



ELECTION
SYSTEMS & SOFTWARE

Proven Solutions for the World of Elections

The iVotronic Voting System Operator's Manual

Election Systems and Software, Inc.

Corporate Headquarters
11208 John Galt Blvd.
Omaha, NE 68137, USA
Phone: (402) 593-0101
Toll Free Inside U.S.: (800) 247-8683
Fax: (402) 593-8107
<http://www.essvote.com>

1945

1946

1947

1948

1949

1950



ELECTION
SYSTEMS & SOFTWARE

Proven Solutions for the World of Elections

The iVotronic Voting System Operator's Manual

Version 6.1

June, 2001

Election Systems and Software, Inc.

Corporate Headquarters

11208 John Galt Blvd.

Omaha, NE 68137, USA

Phone: (402) 593-0101

Toll Free Inside U.S.: (800) 247-8683

Fax: (402) 593-8107

<http://www.essvote.com>

Copyright © 2001 All Rights Reserved

© 2001 by Election Systems & Software, 11208 John Galt Blvd., Omaha, NE 68137-2364. All rights reserved. Printed in the USA
Revisions for version 6.1: ES&S, Omaha, NE

All information contained in this manual is proprietary to Election Systems & Software. No part of this document may be photocopied or reproduced in any manner without the prior consent of Election Systems & Software.

The iVotronic Voting System is a trademark of Election Systems & Software. Windows - and Windows 95 are trademarks of the Microsoft Corporation. All other products mentioned are the sole property of their respective manufacturers.

Disclaimer

Election Systems & Software does not extend any warranties by this document. All product information and material disclosure contained in this document is furnished subject to the terms and conditions of a purchase or lease agreement. The only warranties made by Election Systems & Software are contained in such agreements. Users should ensure that the use of this equipment complies with all legal or other obligations of their governmental jurisdictions. The iVotronic Voting System is a registered trademark of ES&S.



Vision Statement

Recognized global leader in providing innovative solutions and services to the election industry. These quality solutions and services are developed and delivered by people dedicated to the highest standards of ethics, integrity and the process of continuous improvement.

The result will allow our present and future customers to have a positive and lasting impact on the growth of democracy worldwide.

Who We Are

The World Leader in Automating the Election Process

ES&S is a company of dedicated people building integrated systems and developing solutions for the election official's total management needs:

- Election and voter registration management software
- Ballot counting and tabulation hardware
- Election information management software



Faint, illegible text in the upper middle section of the page, possibly a header or introductory paragraph.

A small, faint mark or word centered on the page, possibly a signature or a specific reference.

A line of faint, illegible text in the middle section of the page, possibly a separator or a specific heading.

A block of faint, illegible text in the lower middle section of the page, possibly the main body of a letter or document.

A small, faint mark or signature in the bottom left corner of the page.

Table of Contents

Chapter 1: Introduction	1
Contacting ES&S for Technical Support.....	3
Chapter 2: Equipment Overview	5
iVotronic Voting System Equipment.....	5
Supervisor and Voter Terminals and PEBs.....	6
Communications Pack	8
PEB Reader	10
Assembled iVotronic Voting Booth.....	10
System Interface: The Touch Screen	11
System Environment.....	12
Chapter 3: Operating Modes and Ballot Loading Systems	13
Election and Service Mode	13
Ballot Loading Systems	13
Poll Worker Activated System.....	14
Voter Activated System	15
Chapter 4: Pre-Election Day Preparation	17
Service Menu and Election Central Applications Menu.....	17
Initiating Service Mode.....	19
Service Menu Password.....	19
Election Coding Preparation	20
Starting Election Qualification Trail.....	20
Qualifying PEBs	20
Preparing PEB for Polling Location	21
Test Voting.....	21
Election Jurisdiction Preparation	22
Replacing and Recharging Batteries	22
Calibrating the Screen.....	25
Clearing and Testing Terminals.....	27
Setting Time and Date	28
Setting Volume	30
Qualifying PEBs	32
Testing the Printer.....	33
Testing the Election	34
Testing the Modem	35
Delivering Terminals to Polling Places	36
Chapter 5: Poll Worker Election Day Procedures.....	37
Voting Booth Assembly.....	37
Opening Polling Locations.....	40
Opening iVotronic Terminals	40

Activating the Terminals.....	42
Coding a ballot.....	43
Voting	44
Automatic Over-Vote Protection	44
The Write-In Vote.....	45
Viewing All Pages	46
Summary Review Ballot	47
The VOTE Button.....	48
Casting a Ballot for a Voter	49
Casting a Ballot as Voted.....	50
Cancelling a Ballot or Casting a Blank Ballot	50
Closing Polls	50
Closing a Terminal Early	50
Closing Terminals at the Official Time	52
Modeming Results	53
Printing Results.....	54
Printing Report to Screen.....	55
Printing Report to Printer.....	55
Closing Polling Location	56
Chapter 6: Post-Election Tasks	57
Reporting Combined Polling Location Results	57
Uploading PEB Vote Results from Supervisor Terminal	57
Uploading Vote Results from PEB Reader.....	59
Recollecting Votes for a Recount	59
Collecting Votes from Voter Terminals.....	59
Retrieving Audit Information.....	61
Randomized Audit Trail	61
Preparing PEB for Serial Audit.....	61
Collecting Audit Data with Prepared PEB.....	62
Uploading Terminal Audit Data	62
Storing the iVotronic.....	63
Chapter 7: Election Specific Capabilities and Safeguards.....	65
Election Capabilities	65
Partisan and Nonpartisan Contests.....	65
Straight Party Voting	65
Straight Party Reporting.....	65
Crossover Contests.....	66
Propositions	66
Primaries and Split Precincts	66
Pick Your Party Primary	67
Undecided Voter Primary	68
Election Capabilities Upgrades.....	69
General Safeguards	69
Randomized Audit Trail	70
Protection Against Fraud	70
Protection Against Over-voting	71

Protection Against Power Drain	71
Protecting the Ballot Format	72
Redundancy	72
Protection Against Malicious Vote Fraud	73
Prior to the Election	74
During the Election	76
After the Election	77
Chapter 8: Contingency Plans	79
Supervisor Terminal Failure	79
Master PEB Failure	79
Voting Terminal Failure	79
Voter PEB Failure	80
Printer Failure	80
Check the Power Switch	80
Check the Cables	80
Check the Batteries	81
Check the Paper Tape	81
Check the Printer Ribbon	81
Swap Printers	81
Failed Modem	81
Check Phone Line	82
Check Cable	82
Swap Modems	82
Rely on PEB	82
Error Messages	82
Battery Failure	82
Error: 256: 16384	83
Internal Malfunction, Terminal is Shutting Down	83
Troubleshooting	83
Terminal Screen is Difficult to Read (Too Dark or Too Light)	83
Terminal Emits a Chirping Sound	83
Voter Prematurely Leaves Terminal	83
Failure to Print Zero Tape	84
Appendix A: ADA Functions	85
To vote in Voice mode:	86
Recording Voice Files	87
Transferring Voice Files to the iVotronic	88
Appendix B: Three Steps to Voting (Poll Worker Activated System)	89
Appendix C: Four Steps to Voting (Voter Activated System)	91
Appendix D: Glossary	93

Faint, illegible text at the top of the page, possibly a header or introductory paragraph.

Second block of faint, illegible text, appearing to be a continuation of the document's content.

Third block of faint, illegible text, showing further details or a separate section.

Fourth block of faint, illegible text, continuing the narrative or list of items.

Fifth block of faint, illegible text, possibly a concluding paragraph or a list of references.

Final block of faint, illegible text at the bottom of the page.

Chapter 1: Introduction

The iVotronic is a direct recording electronic (DRE) touch screen voting system. Voters cast ballots on terminals that are activated by inserting personalized electronic ballots (PEBs). PEBs are programmed prior to the election with all the appropriate election information including ballot styles. No paper ballots or preprinting is required. PEBs open the polls, load ballots onto terminals for voters, and collect and tally all votes from each terminal at the end of Election Day. Once all votes from a polling location are collected into a PEB, that PEB in combination with a closed terminal and communications pack is used to print all polling location election results. Polling place election results can also be transferred via modem from the polling place to election headquarters with the same equipment.

The iVotronic DRE touch screen voting system has numerous features that provide advantages over other types of voting equipment, including:

- Paperless, no ballot printing costs or ballot overlays.
- No moving mechanical parts that are prone to failure.
- Large, easy to read, backlit color touch screen.
- Touch screen allows voters to easily correct errors or misvotes.
- Easy to use alpha template screen for write-in voting.
- Write-in votes can be changed or cancelled prior to casting the ballot.
- Minimal difficulty with last minute ballot setup changes.
- Easily accommodates primary elections.
- Easily accommodates split precincts.
- Prevents voters from over-voting or spoiling ballots.
- Provides instant voter feedback by highlighting candidate choices.
- Easy to understand prompts help guide the voter through the voting process.
- Easy to use paging system can require the voter to "VIEW" all pages before casting their vote, which discourages ballot fall-off.

The iVotronic Voting System can operate anywhere: election headquarters for pre/post election administrative purposes and "one-stop" absentee voting, and at the polling location for traditional, curbside, and challenged voting. This adaptability is important as election laws and procedures vary from state to state. Using this guide, each election jurisdiction should develop its own election administration procedures.

The manual is divided into the following sections:

- **Equipment Overview.** This section describes the iVotronic terminals and PEBs, the communications pack, the voting booth, and the system interface and environment.
- **Operating Modes and Ballot Loading Systems.** This section describes the iVotronic terminal's Election Mode and Service Mode, and the two ballot loading methods, which are the Poll Worker Activated System and the Voter Activated System.
- **Pre-Election Day Preparation.** This section discusses how to prepare the iVotronic terminals and PEBs for an election, and how to test the election, the printer, and the modem.
- **Election Day Procedures.** This section provides step-by-step instructions for opening the poll locations, voting, closing the poll locations, and printing and modeming the polling place results.
- **Post-Election Tasks.** This section discusses combined results reporting, recount procedures, audit information retrieval, and other post-election tasks.
- **Election Specific Capabilities and Safeguards.** This section describes how the iVotronic works for different kinds of elections and contests (primaries, straight party races, etc.) and then discusses safeguards against system failure and election fraud.
- **Contingency Plans.** This section provides procedures to use if the equipment malfunctions and troubleshooting methods for unplanned situations.
- **Appendix A: ADA Functions.** This section explains how to use the iVotronic for visually impaired voters.
- **Appendix B: Three Steps to Voting.** This section explains the steps for voting when using the Poll Worker Activated ballot-loading system. It can be used as a voter instruction handout on Election Day.
- **Appendix C: Four Steps to Voting.** This section explains the steps for voting when using the Voter Activated ballot-loading system. It can be used as a voter instruction handout on Election Day.
- **Appendix D: Glossary.**

Contacting ES&S for Technical Support

This user's manual should aid you in accomplishing most iVotronic-related tasks. However, if you need additional assistance, or if you encounter a processing problem or system error, ES&S's technical support staff can provide advice and help you resolve the situation.

When you contact ES&S for technical support, please be near your equipment. In addition, be prepared to provide the following information to the support representative:

- **The model number** of the product you are using.
- **The *exact* wording of any messages** that appeared on your iVotronic.
- **A description of what happened**, what you were doing when the problem occurred, and how you tried to solve the problem.

Support representatives are available between 8:00 AM and 5:00 PM Central Standard Time; however, support hours are extended during election periods.

You can contact an ES&S support representative in several ways:

Telephone: 800-247-8683 (USA & Canada) or
402-593-0101 (International)

Fax: 402-593-8107

Mail: Election Systems & Software
11208 John Galt Blvd.
Omaha, NE 68137 USA

Faint, illegible text at the top of the page, possibly a header or introductory paragraph.

Second block of faint, illegible text, appearing to be a continuation of the document's content.

Third block of faint, illegible text, possibly containing a list or specific details.

Fourth block of faint, illegible text, continuing the narrative or list.

Fifth block of faint, illegible text, possibly a concluding paragraph or signature area.

Sixth block of faint, illegible text, appearing to be a final section or note.

Seventh block of faint, illegible text at the bottom of the page.

Chapter 2: Equipment Overview

iVotronic Voting System Equipment

The iVotronic Voting System equipment components include color coded voting terminals and personalized electronic ballots, communications hardware, and easy to assemble voting booths.

The iVotronic System hardware includes:

- Red supervisor terminal(s).
- Red supervisor personalized electronic ballots (PEBs).
- Blue voting terminal(s).
- Blue voter personalized electronic ballots (PEBs).
- Communications Pack(s) with a printer and optional modem.
- PEB reader for transferring PEB data to a PC.
- AC adapter for recharging terminal batteries.

Voter terminals come in a convenient carrying case that holds everything necessary to assemble a voting booth for the terminal. The carrying case includes the following items:

- Fold-up privacy screens.
- Collapsible legs.
- Padding for the voting terminal.
- Two leg storage brackets.
- A voter instruction card.

The iVotronic System has no external cables or wires connecting the terminals to a keyboard, a power supply, or to each other. All equipment is battery powered (the terminal can be recharged with an AC adapter while in use) and self-contained. Terminals only communicate with one another when a PEB is manually inserted into a terminal PEB slot. The independent nature of the terminals prevents widespread equipment failure on Election Day.

The iVotronic terminal weighs less than nine pounds, allowing for ease of operation during maintenance, polling location delivery, and Election Day setup.

Supervisor and Voter Terminals and PEBs

There are two distinct iVotronic terminals and PEBs: the supervisor terminal and PEB, which are red, and the voting terminal and PEB, which are blue. Supervisor PEBs are programmed with ballot data before every election. On Election Day, polling location officials use the supervisor equipment to open the polls, load ballots onto either voter PEBs or voting terminals (depending on the ballot loading system used by the jurisdiction), close the polls, and print polling location results.

During the election, voters use voting terminals and PEBs. Ballot selections are made by pressing on the iVotronic screen with either a stylus or finger. When all candidates are selected, the red VOTE button is pressed to cast the ballot. The iVotronic terminal may also be fitted for compliance with the Americans with Disabilities Act. For information on the voting process using ADA compliant terminals, consult Appendix A, "ADA Functions."

When a PEB is inserted into a PEB slot, the terminal automatically powers-up and performs a self-test. This process takes about five seconds to complete. All iVotronic terminals may be powered-up in two different operating modes, each of which has different functions and capabilities. By design, the PEBs can be inserted in one direction only. When a PEB is removed, the terminal powers down automatically until another PEB is inserted.

iVotronic Terminal with ADA Features

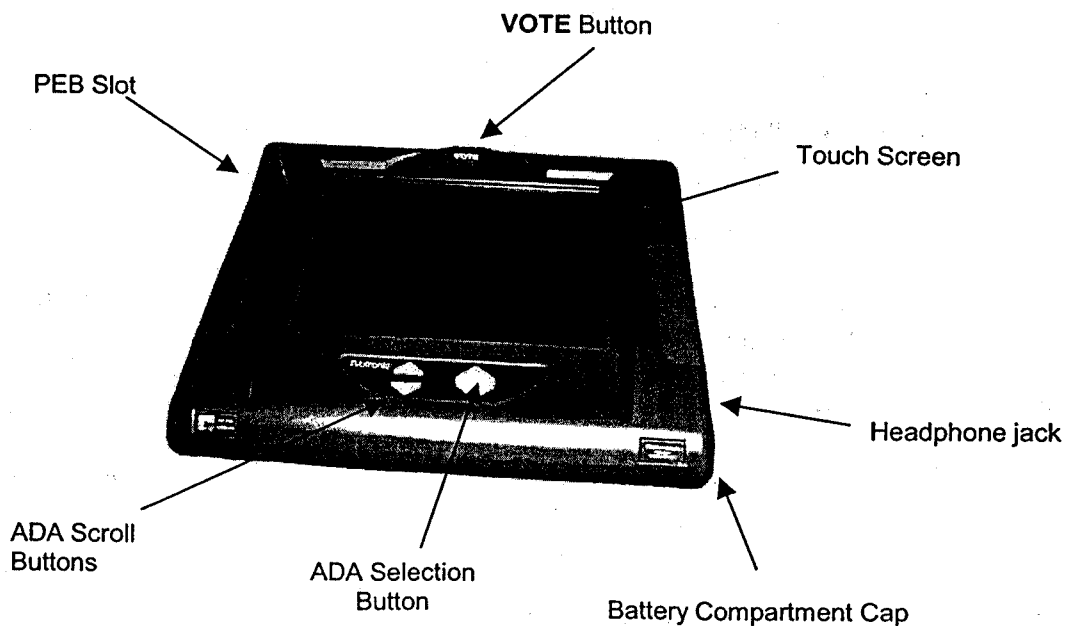

iVotronic Terminal Back View

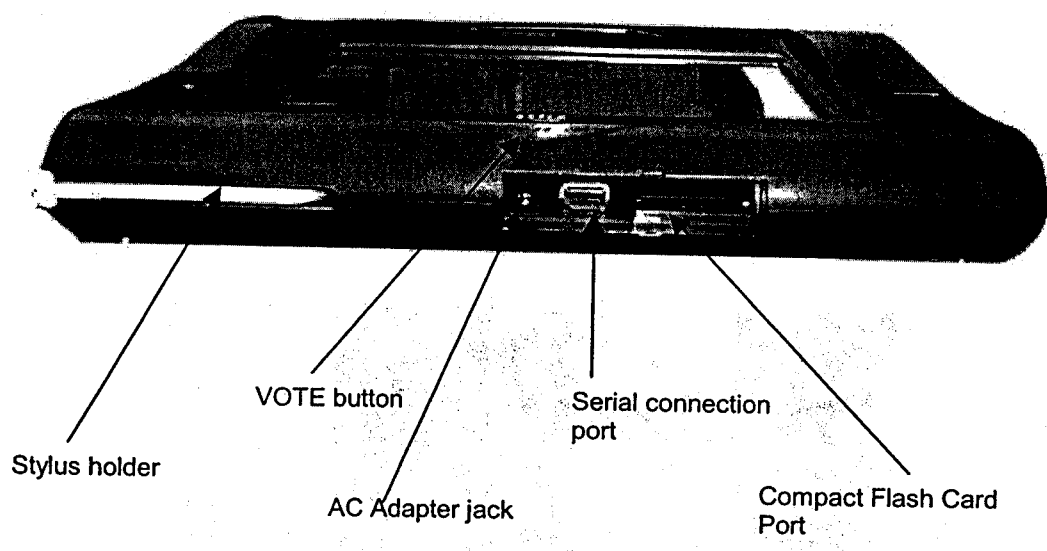

PEB Front View

PEB Back View

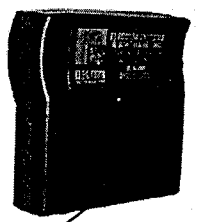
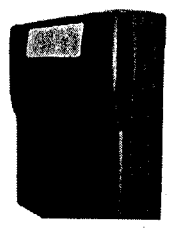

Infrared communications window

Communications Pack

The iVotronic Voting System includes a communications pack with a serial printer and option modem. A separate battery pack, also contained within the communication pack, powers the printer. During the election process, the printer produces vital information such as a zero tape when required and the polling location election results report.

Communications Pack

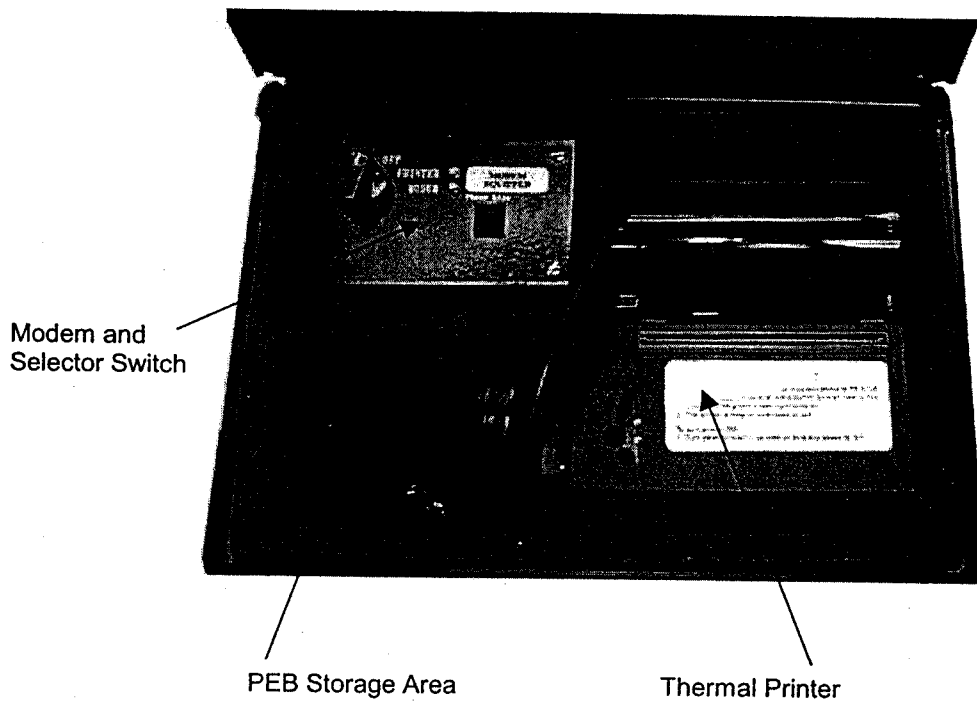

Printer

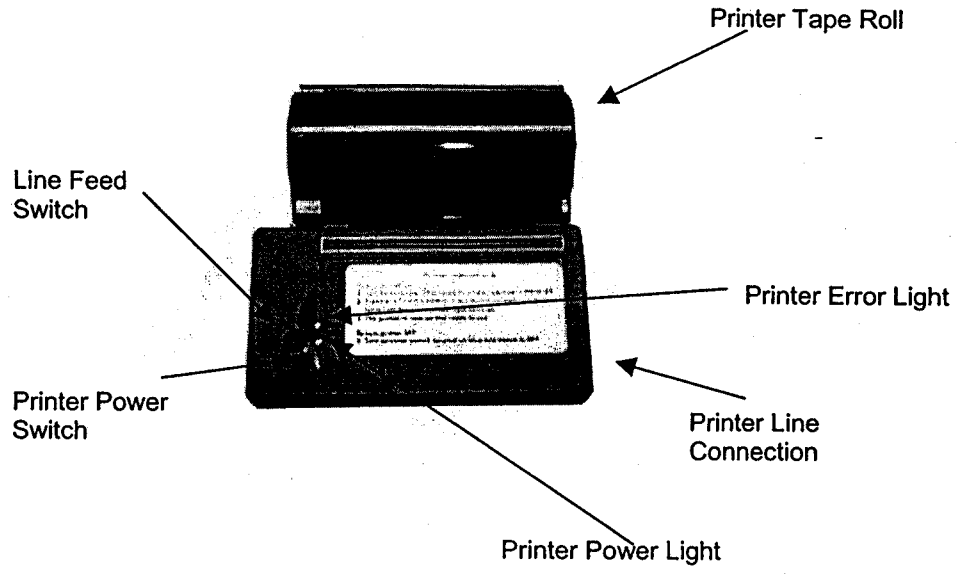

Modem and Selector Switch

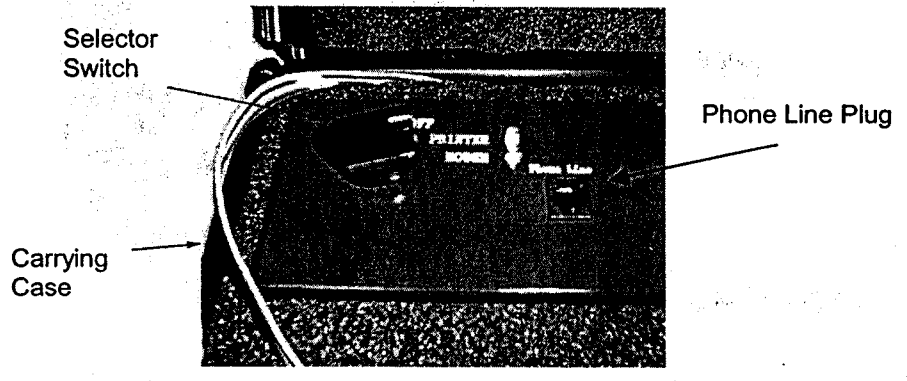

PEB Reader

The PEB reader connects to a PC so that information can be uploaded from a PEB to the PC. Election results data can be uploaded in this manner.

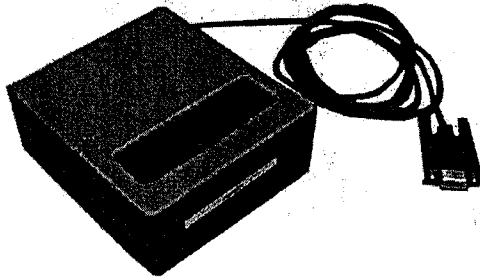

Assembled iVotronic Voting Booth

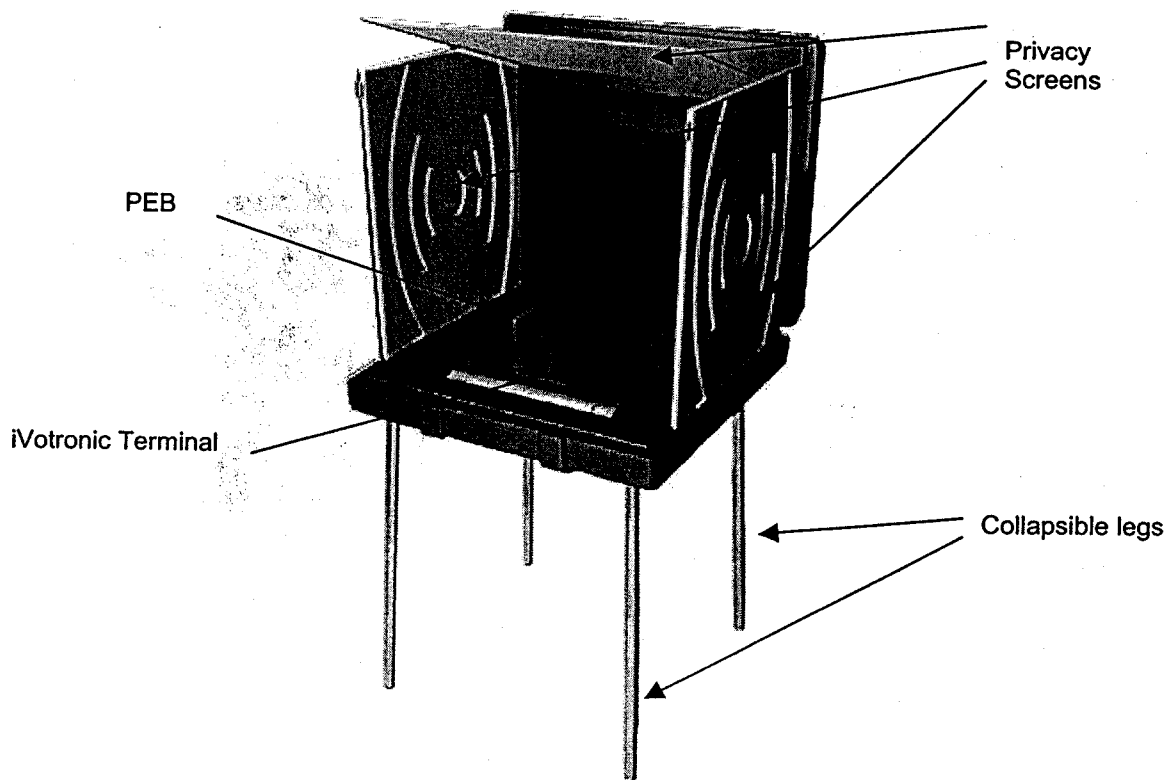

System Interface: The Touch Screen

An easy-to-use touch screen acts as the interface between the iVotronic terminal and the system users. This touch screen displays ballots to the voters, and system messages, instructions and settings to the election officials. Reusable PEBs activate the touch screen.

Once the touch screen is activated, ballot selections can be made on the iVotronic by applying light pressure to the screen with either a plastic, pencil-shaped stylus or a fingertip. Generally, the area that the user presses is a box located next to his or her choice of function, ballot, candidate, etc.

For example:

CANDIDATE 1

PRECINCT 1 BALLOT

When a user presses inside a box on the screen, it displays an X and the choice becomes highlighted in color. For example:

CANDIDATE 1

Once a selection has been made, pressing the same box a second time cancels the choice (i.e., the X and highlight disappear).

For iVotronic functions in which there is no actual selection but an option to increase or decrease (increasing or decreasing the volume on ADA functions, for example) an X will not be displayed in the box. Each time the option is selected, the targeted setting will be increased or decreased accordingly.

System Environment

The iVotronic can operate in many settings, at election headquarters, curbside, or at the precinct. This adaptability results from several key features. First, the iVotronic requires no AC power to run because all system components are battery operated, though the terminal can be plugged into a wall socket to charge the batteries while in use. Second, iVotronic terminals are totally self-contained, with no wires or cables connected to the terminal or other system components. Third, all terminals are lightweight; therefore, easy to transport, assemble, and service.

The only environmental restriction for the iVotronic Voting System pertains to temperature and humidity. Normal operating conditions require a temperature range of 60-100° Fahrenheit and non-condensing humidity of less than 95%.

Chapter 3: Operating Modes and Ballot Loading Systems

Both the operating mode and the ballot loading system affect how the iVotronic Voting System is used. The two operating modes, Election Mode and Service Mode, will be used to perform different actions on the iVotronic terminal. The ballot loading system (chosen by the Election Administrator) will determine how ballots are loaded onto voter terminals.

Election and Service Mode

The two modes in which the terminals may be powered-up are the Election Mode and the Service Mode. Inserting a PEB into the terminal PEB slot accesses Election Mode. The Election Mode is used for normal election operations at the polling location. Both supervisor and voting terminals are used in the Election Mode to open the polls, load electronic ballots, vote, close the polls, and report polling location election results.

Service Mode is used by election officials to perform a variety of functions before and after the election. Service Mode functions include pre/post election equipment preparation, screen display adjustment, diagnostic tests, centralized election results reporting, and audit trail retrieval.

To access Service Mode, press and hold the red VOTE button on the upper center of the terminal while inserting a PEB. Release the VOTE button when several rapid beeps (chirping tones) are heard and the Service Mode will be initiated.

Ballot Loading Systems

In Election Mode, ballots can be loaded on to the voting terminal with two different systems; these are the Poll Worker Activated System and the Voter Activated System. The two ballot loading systems require different equipment configurations and functions. Jurisdictions must choose which ballot loading system (or combination of systems) suits their needs before purchasing the iVotronic System. Because all terminals are generic in nature, they can operate with either ballot loading system. The type and quantity of equipment purchased determines which ballot-loading system is used.

Poll Worker Activated System

To use this system the jurisdiction maintains a majority of voting terminals with supervisor PEBs for polling location use, and several supervisor terminals for use at election headquarters. No voter PEBs are used in this ballot-loading system. The supervisor terminals are used primarily for pre/post Election Day administrative purposes such as uploading election data to a PC. ES&S recommends one blue voter terminal per 250 registered voters and one supervisor PEB for every 2-3 voter terminals used in the election.

Before the election, a number of supervisor PEBs are programmed for each polling location. These supervisor PEBs contain all of the ballots required by the polling location.

In addition, each polling location must designate *ONE* of the supervisor PEBs as a "master PEB" to collect the Election Day totals after closing the polling location. To prevent confusion by election officials, the master PEB **MUST** be labeled so it can be easily distinguished from the other supervisor PEBs. The master PEB is used to open the polls and print a zero report, close the polls, collect the polling location Election Day totals, and to print or transmit all polling location reports.

Throughout Election Day, poll workers use the supervisor PEBs to activate voter terminals with the appropriate voter ballot. When a voter approaches an open iVotronic terminal, a poll worker inserts one of the supervisor PEBs into the iVotronic to load a ballot for the voter. After the ballot is loaded (approximately five seconds), the official removes the supervisor PEB and steps aside so that the voter can make selections in private.

Once Election Day ends and the polling location closes, the polling location official must ensure that the Election Administrator receives the master PEB containing the final vote totals for the polling location. The information from the master PEB can be transferred to election headquarters using one of two methods: results can be transferred to election headquarters via modem, or the master PEB can be physically transported to election headquarters. The Election Administrator will determine which method is most effective for each polling location.

Voter Activated System

The Voter Activated System differs from the Poll Worker Activated System in that each polling location maintains a combination of supervisor terminals/PEBs and voter terminals/PEBs. Typically, a polling location will have 1-3 supervisor terminals, and two voter PEBs per voter terminal. This system is typically used in jurisdictions that have extended early voting periods as it requires less manpower.

Once a voter's eligibility is verified, the poll worker uses the opened supervisor terminals to load blue voter PEBs with the appropriate ballot. The official gives the voter PEB to the voter, who takes it to the voter terminal. The voter inserts the voter PEB into the voter terminal, which automatically powers up, performs a self-test sequence, and displays the preloaded ballot. The voter selects candidate choices, casts a ballot and returns the PEB to the poll worker. After a PEB has been used, it will not reactivate that terminal or activate any other terminal until a poll worker reloads the voter PEB with another ballot.

In the same fashion as the Poll Worker Activated System, each polling location must designate one of the supervisor PEBs as a "master PEB" to collect the Election Day totals after closing the polling location. To prevent confusion by election officials, the master PEB must be labeled so it can be easily distinguished from other supervisor PEBs. The master PEB is used to open the polls and print a zero report, close the polls, collect the polling location Election Day totals, and to print/modem all polling location reports.

As in the Poll Worker Activated System, when Election Day ends and the polling location closes, the poll worker must make sure that the Election Administrator receives the information on the master PEB containing the final vote totals for the polling location. This information can be transferred to election headquarters via modem, or by physically transporting the master PEB to headquarters.

Chapter 4: Pre-Election Day Preparation

Pre-election day steps take place primarily at the election coding center and at election headquarters. Most pre-election steps use options on the service menu, which is accessed by bringing the terminal up in service mode. The pre-election day preparation steps that follow appear in the order they are conducted, whether they occur at a coding center or at the election jurisdiction. If ES&S is coding the election the County's pre-election preparation will start with the section on recharging and replacing batteries.

Service Menu and Election Central Applications Menu

Officials perform several essential functions before and after the actual election while in the Service menu. The Service menu is password protected. Only key personnel should be trained in and use the Service menu because of its importance in completing a successful Election Day.

Service Menu

Service Menu

- Clear and Test Terminal
 - Set Time and Date
- Qualify PEB(s)
 - Test Printer
- Test Modem
 - Upload Firmware
- Set Volume
 - Elections Central Menu

8:47:22 9/19/2000 Terminal S/N: V002900-6 PEB S/N: PS007191-4
Software Version 6.1.0 Created 5/2/01 15:23
Copyright ES&S, Inc. 1993-2000. All Rights Reserved.

Battery Voltage: 7.26V OK

Note: The Set Volume option on the Service menu only appears on iVotronic terminals that offer ADA functions.

The Elections Central Applications menu is accessed through the Service menu. Like the Service menu, the Elections Central Applications menu contains commands that are performed before and after the election. This menu is also password protected, and should only be used by trained personnel. The Elections Central Applications menu offers different options on a supervisor terminal than it does on a voter terminal. These menus are shown below.

Election Central Applications Menu—Supervisor Terminal

Elections Central Applications Menu

- Prepare PEB for Polling location
- Test Vote
- Clear Supervisor PEB Vote Totals
- Prepare PEB for PEB Audit
- Prepare PEB for Serial Audit
- Upload PEB Vote Results
- Upload PEB Audit Data
- Print Report to Screen
- Print Report to The Printer
- Start Election Qualification Trail
- Color Option Numbers
- Exit to Service Menu

8:47:22 9/19/2000 Terminal S/N: V002900-6 PEB S/N: PS007191-4
Software Version 6.1.0 Created 5/2/01 15:23
Copyright ES&S, Inc. 1993-2000. All Rights Reserved.

Battery Voltage: 7.26V OK

Note: The Color Option Numbers option is a reference screen used for election coding in order to view possible ballot color options.

Elections Central Applications Menu—Voter Terminal

Elections Central Applications Menu

- Upload Terminal Audit Data
- Print Report to Screen
- Print Report to Printer
- Exit to Service Menu

8:47:22 9/19/2000 Terminal S/N: V002900-6 PEB S/N: PS007191-4
Software Version 6.1.0 Created 5/2/01 15:23
Copyright ES&S, Inc. 1993-2000. All Rights Reserved.

Battery Voltage: 7.26V OK

Initiating Service Mode

The iVotronic terminal must be started in the Service Mode to access the Service menu and the Election Central Applications menu.

1. Hold down the **VOTE** button while inserting any supervisor PEB. The **VOTE** button must be held down until a rapid series of beeps has been heard, approximately five seconds from the time the PEB is inserted.
2. Release the **VOTE** button as soon as these rapid beeps are heard. The Calibration query screen appears.
3. Press anywhere on the screen to bypass the Calibration query screen. When the screen calibration is bypassed the Service Menu Password screen is displayed.

Note: To start the calibration process, press the **VOTE** button and follow the screen instructions.

Service Menu Password

1. Consult the Election Administrator or refer to the *ES&S iVotronic Voting System Maintenance Manual* for the correct password to gain entry to the Service Menu. The Service Menu Password screen appears below:

Service Menu Password Screen

Please Enter Service Menu Password

A B C D E F G H I J K L
M N O P Q R S T U V W Y X
Y Z 0 1 2 3 4 5 6 7 8 9
, . - (SPACE) (BACKSPACE)

>>Accept<< >>Cancel<<

Press letters, (SPACE) and numbers as desired.
Press (BACKSPACE) to remove mistakes.
Press Accept or Cancel when you are done.

2. To enter a password, select each letter of the password from the displayed alphanumeric list by pressing on it. Use **BACKSPACE** to correct mistaken entries. Asterisks will appear on the line above the alphanumeric list for each letter selected.
3. When the password has been entered correctly, press **Accept**. The Service menu will be displayed.

Entering an incorrect password, or pressing Cancel results in the following message: "Please remove PEB. Illegal Password."

Election Coding Preparation

Several menu items on the iVotronic Election Central Applications menu are used to prepare the PEBs and terminals for each election. These steps may be done at election headquarters if the jurisdiction is coding the election, but typically they are done at an ES&S coding center.

Starting Election Qualification Trail

This function *must be performed first* when readying the equipment for an election. Prior to using the Prepare PEB for Polling Location option, a new Election Qualification Trail must be started. The "Start Election Qualification Trail" option automatically creates a new code in the supervisor terminal that is then transferred to all PEBs when they are "Qualified" and "Prepared." The Qualified PEBs then transfer this code to all terminals when they are used to Clear and Test them for the election. Because this Qualification Code facilitates the generation and retrieval of audit data for each election, it is imperative that every election is assigned a new and unique Qualification Code.

To access this feature the user must enter an Election Qualification Password.

Qualifying PEBs

All PEBs must be qualified before each election. At the election coding center supervisor PEBs must be qualified before they are loaded with ballot data, in order to receive the qualification code used to retrieve audit data. After qualification, PEBs are blank and always need to be reprogrammed with ballot data.

Preparing PEB for Polling Location

The "Prepare PEB for Polling Location" option downloads polling location-specific ballot data programmed from the Hardware Programming Manager, through the supervisor terminal and onto the inserted "Qualified PEB." The Hardware Programming Manager runs on an IBM-compatible PC. The Programming Manager generates all viable ballot styles for the election, which are then assigned to polling locations based on district associations and splits. These polling location-specific styles are then downloaded to the appropriate number of PEBs for any one polling location. In essence, this feature prepares (i.e., programs) the master and supervisor PEBs for each polling location in the upcoming election. Typically this step is done at an ES&S coding center.

Test Voting

The "Test Vote" option allows users to immediately review the ballots programmed onto a PEB by the "Prepare PEB for Polling Location" option without altering the PEB or using a voter terminal to vote the ballot. This Test Vote function permits the user to select and vote all programmed ballots before an election in a non-intrusive manner. The Test Vote results do not record on the PEB or terminal when the user is finished.

To Test Vote a ballot, remove and reinsert the PEB just programmed by the "Prepare PEB for Polling Location" option in the supervisor terminal PEB slot, and select Test Vote from the ECA Menu. The Ballot Selection Screen appears and the user will select one of the ballots available for voting. Once selected, the ballot is displayed for voting on the supervisor terminal. To exit the Test Vote feature and return to the ECA Menu, press the VOTE button on the supervisor terminal. To test a second ballot type (if available), repeat the above steps.

Election Jurisdiction Preparation

The election jurisdiction personnel always do at the following Pre-Election Day tasks.

Replacing and Recharging Batteries

The first step in preparing for an upcoming election consists of replacing batteries for all Communications Packs and recharging all iVotronic terminals. The Communications Pack batteries from the previous election should have already been removed. The D-cell batteries that power the Communications Packs are consumable, so new batteries must be installed before every election.

Terminal Battery Recharging

The iVotronic terminal is powered by six D-sized NiMh batteries that can be recharged up to 1000 times. The iVotronic batteries are recharged through use of the AC adapter.

1. Connect the AC adapter to the adapter jack located on the back of the iVotronic terminal.
2. Plug the adapter into the wall socket.
3. Remove the adapter after 12 hours. The batteries should be fully recharged. The iVotronic can also be recharged during voting by plugging the adapter into a wall socket.

Terminal Battery Replacement

To replace a damaged or defective battery pack in the terminal:

1. Access the iVotronic terminal battery compartment by lifting the front of the terminal out of the carrying case.
2. Locate the battery cap on the right side of the terminal.

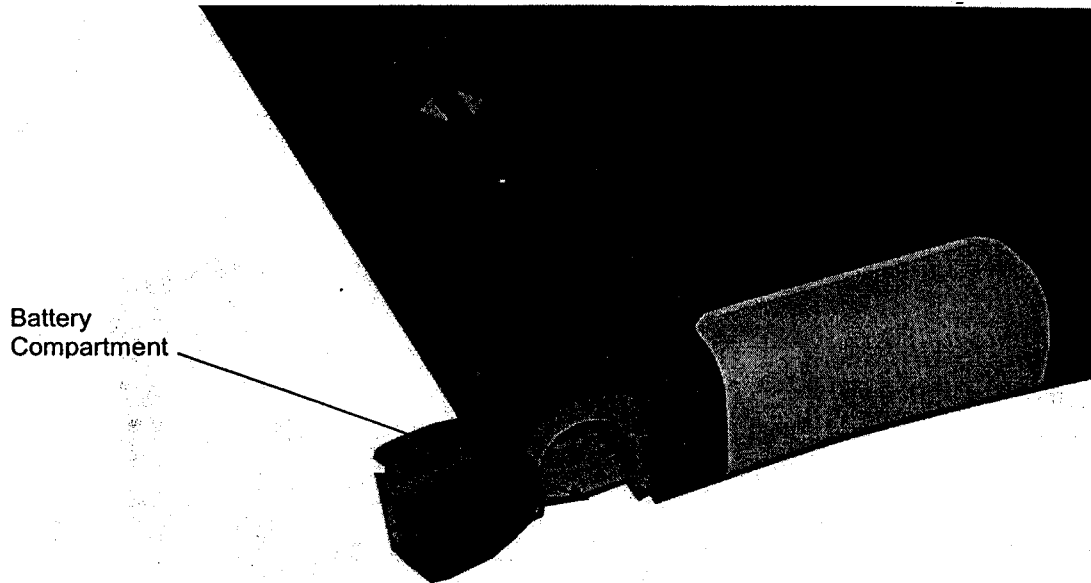

3. Press the battery cover release button and turn the battery compartment cover clockwise until the battery pack can easily slide in and out of the battery compartment.
4. Disconnect the snap connector and slide the battery pack out of the terminal.
5. Install a NiMh battery pack by inserting the flat (negative) end into the terminal first and then reconnect the snap connector.
6. Reattach the battery compartment cover by turning it counterclockwise until it snaps back into place. Make sure the cover is firmly attached.

Because the possibility of defective battery packs exists, ES&S recommends that extra battery packs be available during the election. Battery packs may be purchased from ES&S.

To reduce the risk of corrosion damage, ES&S recommends that fresh batteries be installed in all Communications Packs no earlier than four weeks before every election, and then removed within four weeks after the election. Because the possibility of defective new batteries exists, ES&S recommends that extra new batteries be available at each precinct during the election.

Calibrating the Screen

All iVotronic terminals should be calibrated before each election. The Touch Screen Calibration screen allows the user to adjust the screen so that the location pressed on the screen coincides exactly with the location read by the terminal. Touch screen calibration can be repeated as many times as necessary to achieve an effective calibration.

1. Access the Service Mode by pressing the **VOTE** button while inserting a supervisor PEB. The calibration query screen appears.

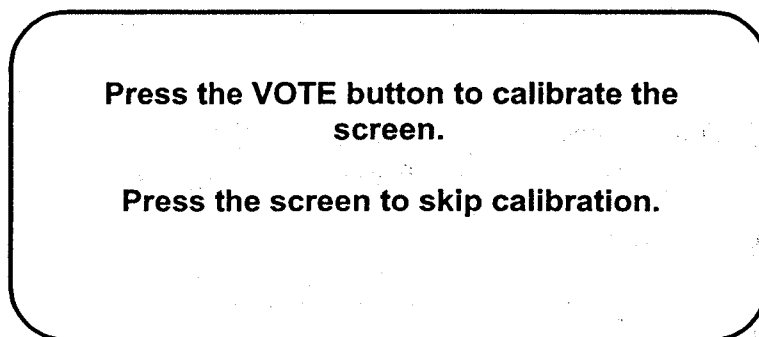

Calibration Query Screen

2. Press the **VOTE** button a second time to display the **Touch Screen Calibration** screen and begin the calibration.
3. Press the center of each "X" as it moves around the screen. There are 20 presses total, starting in the upper left corner and working around the screen in various locations, in a clockwise rotation. When the last "X" is pressed, the **Touch Test** screen appears.

Note: The following illustration represents the number of times the screen must be pressed during calibration. The numbers on the illustration represent the location and order in which calibration "X's" will appear on screen.

Example of Touch Screen Calibration screen

1	2	3	4
Touch Screen Calibration			
16	17	18	5
15			6
Press Line Intersection			
14	19	20	7
13			8
12	11	10	9

4. Complete the Touch Test by pressing the screen in several locations. An "X" should appear directly under the pressed location.

Touch Test Screen

Touch Test
Verify That Cross Follows Stylus
Press the VOTE Button to Exit

5. Press the **VOTE** button to complete the calibration and return to the calibration query screen.

If necessary, press the VOTE button a second time to repeat the calibration or press the screen to bring up the Service Menu Password screen.

Clearing and Testing Terminals

Before every election, each iVotronic terminal that is to be used in that election *MUST* be cleared and tested. Failure to perform the clear and test function on a terminal before an election results in the inability to open the terminal for voting on Election Day.

Be aware that for all iVotronic terminals (voter and supervisor), selection of this option will completely erase *ALL* voting information stored on the terminal. In fact, this function is the *only way* to erase the votes stored on the voter terminals. Clearing and testing a terminal verifies, and then overwrites the previously stored information. Any errors in the stored information or the clear and test sequence render the unit unusable until it is repaired by qualified service personnel.

1. Access the **Service Menu** with the appropriate password.
2. Select the **Clear and Test** option from the **Service Menu** by pressing the adjacent box. The Clear and Test Password screen appears.
3. Enter the Clear and Test password. If necessary contact the Election Administrator to obtain the Clear and Test password.

Note: If a terminal has not been closed from the previous election, an override password must be entered before the Clear and Test password may be entered. When the correct password(s) has been entered, the terminal asks the user to verify the function selection a second time with the following screen:

Clear and Test Verification Screen

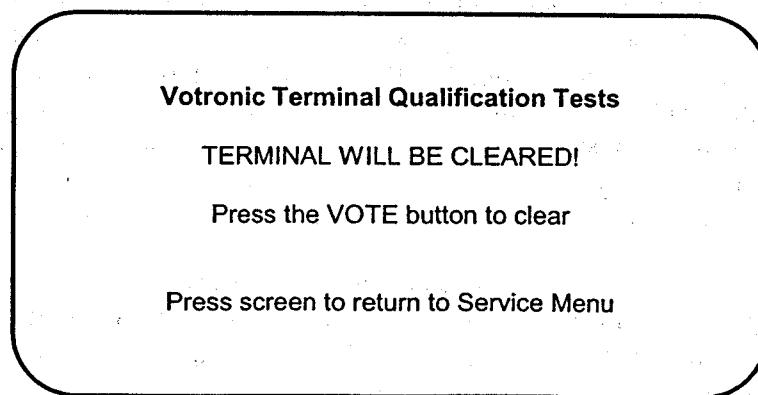

The image shows a rounded rectangular screen with a black border. The text inside is centered and reads:

Votronic Terminal Qualification Tests

TERMINAL WILL BE CLEARED!

Press the VOTE button to clear

Press screen to return to Service Menu

4. Press the **VOTE** button and the terminal immediately begins to clear and test itself. If the user presses the screen, the terminal bypasses the clear and test feature and returns to the Service Menu.

When the clear and test function finishes, the terminal displays a message informing the user that the terminal is qualified.

Clear and Test Message Screen

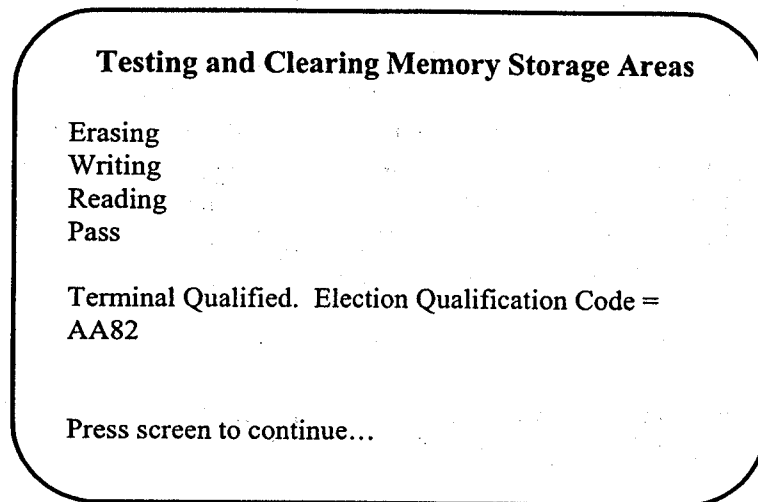

6. Press the screen to return to the Service Menu.

Setting Time and Date

For accurate time stamping of the election process, the internal date and time on all terminals must be checked. The opening and closing times of the polls reported on the polling location results tape reflect these internal times. It is especially important that the iVotronic terminals possess the correct date and time, because the supervisor PEBs are programmed with the correct poll closing date/time. The polls will not close normally if this preset closing date/time has not been met on the iVotronic terminals. The iVotronic System is equipped with an override password that allows election procedures to continue in situations where unexpected date and time differences occur.

The Set Time and Date feature also allows use of an Automatic Daylight Savings Time Correction. When this option is selected the clock automatically adjusts itself for daylight savings time. A line of text appears below the option, which identifies whether the clock is currently in daylight savings time.

Note: New date and time settings are not saved until the Done option is selected.

1. Select the **Set Date and Time** option from the **Service Menu** by pressing the adjacent box. The Set Date and Time screen appears displaying the terminal's current, local, internal date and time.

Set Date and Time screen

Enter time in 24 hour format.

Press and hold to slew value.

▲
 13:18:21 06/26/1997 Thursday

▼ DONE

USE AUTOMATIC DAYLIGHT SAVINGS TIME CORRECTION

IN DAYLIGHT SAVINGS TIME

2. Change time and date, as necessary. To increase a number, the press the adjustment box located directly above it. To decrease a number, press the box located directly below it. Pressing and holding a box will continue cycling the number. Months, days and years automatically roll over to the next logical number.
3. Check to ensure that the **Use Automatic Daylight Savings Time Correction** option is selected. An X should appear in the box associated with this option. ES&S recommends that all jurisdictions that adhere to daylight savings time use this option.
4. Press the **Done** option to save the new settings and return to the **Service Menu**.

Note: The year must be entered in a four-digit format and the month/date in a two-digit format. The time must be entered in a 24 hour format (see the conversion chart below).

24 Hour Conversion Chart

1:00 AM	01:00
2:00 AM	02:00
3:00 AM	03:00
4:00 AM	04:00
5:00 AM	05:00
6:00 AM	06:00
7:00 AM	07:00
8:00 AM	08:00
9:00 AM	09:00
10:00 AM	10:00
11:00 AM	11:00
12:00 PM	12:00
1:00 PM	13:00
2:00 PM	14:00
3:00 PM	15:00
4:00 PM	16:00
5:00 PM	17:00
6:00 PM	18:00
7:00 PM	19:00
8:00 PM	20:00
9:00 PM	21:00
10:00 PM	22:00
11:00 PM	23:00
12:00 AM	24:00

Setting Volume

This option only applies to terminals equipped with ADA functions.

1. Plug headphones into the jack located on the right side of the terminal.
2. Select **Set Volume** from the **Service** menu.
3. Select **Up** or **Down** to raise or lower the volume accordingly. A range of 0 (lowest) to 255 (highest) can be selected.
4. Select **Test** to hear a test message and check the volume through the headphones.
5. Select **Exit** to return to the **Service** menu.

The first part of the document discusses the importance of maintaining accurate records of all transactions. It emphasizes that every entry should be supported by a valid receipt or invoice. This ensures transparency and allows for easy verification of the data.

Additionally, it is noted that the records should be kept in a secure and accessible location. Regular backups are recommended to prevent data loss in the event of a system failure or disaster.

The second section focuses on the process of reconciling accounts. It describes how to compare the internal records with the bank statements to identify any discrepancies. This step is crucial for ensuring the accuracy of the financial statements.

Any differences found should be investigated immediately to determine the cause. Common reasons include timing differences, bank errors, or missing transactions. Once the cause is identified, the records should be corrected accordingly.

The final part of the document provides a summary of the key points discussed. It reiterates the importance of consistency and accuracy in record-keeping. It also offers some practical tips for streamlining the process and reducing the risk of errors.

Overall, the document serves as a comprehensive guide for anyone responsible for managing financial records. It provides clear instructions and best practices to ensure that all transactions are properly documented and accounted for.

Qualifying PEBs

Before every election, each supervisor and voter PEB must be "Qualified." The election jurisdiction will only need to qualify voter PEBs (Voter Activated System). Supervisor PEBs should have already been qualified by the election coding center. This selection works in the same way for PEBs as the "Clear and Test" selection does for terminals. This option completely erases *ALL* information stored on a PEB and loads the new election qualification code. Previous information is verified and overwritten. Any errors in the previous election data or in the qualifying sequence render the PEB unusable until trained service personnel repair it. After qualification, PEBs are blank and always need to be reprogrammed with ballot data.

During the qualification process, the terminal asks the user to remove the PEB, wait a few seconds, and then reinsert the PEB. This removal step tests the alignment of the communications mechanism between the terminal, the PEB, and the system memory. The terminal will offer to test another PEB when it finishes with the first one. Therefore, the user may qualify a number of PEBs on the same terminal without having to regain access to this menu option for each PEB.

Note: DO NOT qualify red supervisor PEBs once they are loaded with current election ballots.

1. Select the **Qualify PEBs** option by pressing the adjacent box on the **Service Menu Screen**. The PEB Qualification Menu Screen appears.

PEB Qualification Menu Screen

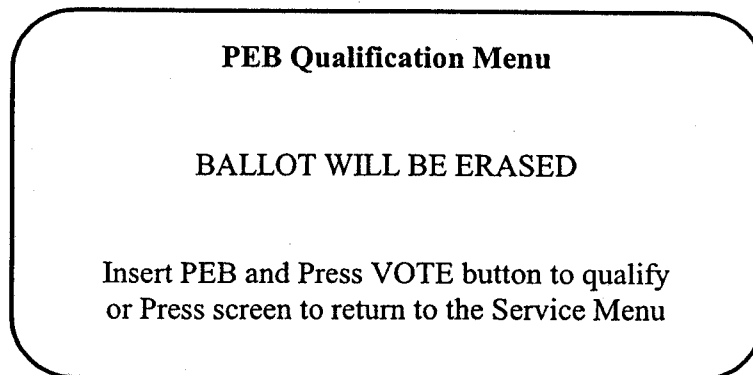

2. Remove the supervisor PEB and insert the PEB to be qualified.
3. Press the **VOTE** button to begin the Qualify PEB function, or press the screen to bypass the function and return to the **Service Menu**.

4. Remove the inserted PEB when the terminal issues an audible alarm and displays the message "Remove Ballot."
5. Reinsert the same PEB when the terminal issues a second audible alarm and displays the message "Reinsert Ballot."
6. Reinserting the PEB allows the terminal to test the alignment of the infrared communications mechanism between the terminal and the PEB. The qualification process continues. When the qualification process is finished, the terminal issues a third audible alarm and displays the message: "PEB Qualified. Election Qualification Code = AA82. Press Screen to Continue."
7. Press the screen to return to the PEB Qualification Menu screen.
8. Remove the PEB from the terminal.

You may repeat this process for additional PEBs to be qualified, or reinsert the supervisor PEB with the current election data and press the screen to return to the Service Menu.

Testing the Printer

The iVotronic Voting System includes a Communications Pack with a thermal printer. A separate battery pack, also contained within the Communication case, powers this printer. During the election process, the printer produces vital information such as a zero tape when required and the polling location election results report. Because of the printer's importance in the election process, it is necessary for Service Personnel to test the printer before every election. Selecting the "Test Printer" option on the Service Menu accomplishes this test. This option prints a message from a iVotronic terminal on the printer.

1. Properly connect the RS232 Ribbon cable, which extends from the Communication Pack Selector Switch to the RS232 Connector on the back of the terminal.
2. Turn the Selector Switch on the Communication Pack to the **PRINTER** position and turn on the printer by pressing the small black button on the printer, until the green light becomes illuminated.
3. Select the "**Test Printer**" option from the **Service Menu** by pressing the adjacent box. The terminal continues to display the Service Menu with the following message in the lower left corner of the screen: "Printing test message to printer..."

4. The printer should immediately line feed once, print "Printer Test Message," and then line feed five more times. During the Printer Test, the Service Menu continues to be displayed.
5. Select the next option from the Service Menu, or remove the PEB and power down.

Note: This test cannot guarantee that the current printer batteries will support the printer throughout the entire election. To lengthen battery life, old batteries should be replaced before each election and the printer should be powered down when not in use.

Testing the Election

After the ballots for the upcoming election are programmed and the equipment is prepared, the Election Administer often runs a test election to verify that the ballots and equipment are properly prepared. The iVotronic Voting System easily supports this activity. However, it is important that the official remembers to clear and test all terminals and clear supervisor PEB vote totals after the test, so that the equipment may be used in the actual election.

To run a test election, the official needs at least one voter terminal, one supervisor terminal, one voter PEB (Voter Activated System only), and one supervisor PEB for the polling location being tested. Contact the Election Administrator to obtain the override password for the test polling location. Most of the steps below are described in detail in the following chapter.

1. Open the polls using a supervisor PEB.
2. Activate the terminal.
3. Vote several times, and verify the accuracy of the ballots.
4. Close the polls (use the override password because polls are being closed early) and collect the votes.
5. Print the report on the printer, or select the **Print Report to Screen** option on the **ECA menu**. Obtain the ECA menu password from the Election Administrator. The screen report is displayed one page at a time. Press the screen to advance the report pages. When the report ends, execution returns to the **ECA Menu**.
6. Verify the accuracy of the test data.
7. Test the modem if it will be used in the election. See the Test Modem

instructions in this chapter.

8. When finished running the test election, use a supervisor PEB programmed for the upcoming election to access the **Service Menu** on the terminals.
9. **Clear and Test** all terminals used in the test election. These voter terminals may then be delivered to any polling location because once they have been cleared and tested, they are no longer associated with the ballot used in the test.
10. Use the supervisor PEB to bring up a supervisor terminal in the Service Mode. Proceed to the **Election Central Applications Menu**.
11. Select the **Clear Supervisor PEB Vote Totals** option from the menu. This function will clear out all vote data from the test election without deleting the ballot stored in that PEB. This step must be completed to bring the PEB back to a pre-election condition. The PEB is then ready for delivery to its polling place for normal election operation.

Note: It is important that you *DO NOT QUALIFY* the supervisor PEB used in the test election. However, you should clear the totals. Clearing the totals leaves the ballot intact and only erases the vote and terminal data, resetting it to open the polls.

Testing the Modem

Many jurisdictions choose to transfer polling location results to election headquarters via modem, rather than wait for the delivery of the master PEB. A pre-election test of the modem located in the iVotronic Communications Pack is vital for smooth delivery of polling location results. Real test data must be used to test the modem transfer. If there are no vote totals in the PEB when you select the Test Modem option, a warning will appear saying "You must have valid votes in the PEB."

During the test the terminal will display a message asking the user to enter the modem initialization string (INIT). The INIT is a series of commands used as defaults to set up the modem and initialize the modem into operation. The INIT screen only appears when testing a modem. It does not appear when actually transferring polling location results on Election Day, because a default initialization string is programmed into the iVotronic Equipment from the jurisdiction's database for every election. Even when testing the modem, the user typically does not need to enter an actual INIT string, but bypasses it by pressing Accept on the screen.

1. Select the **Test Modem** option from the **Service Menu**. An alphanumeric screen identical to the Service Menu Password Screen will appear.
2. From the alphanumeric screen, enter the phone number to which the data will be sent.
3. Next, the terminal will ask you to enter a modem initialization string (INIT). Press **Accept** on the screen without entering a code. The terminal displays the following Modem Instruction screen:

1. Make sure the **Communications Pack** is connected to the back of voting terminal.
2. Plug phone line into jack on **Selection Box**.
3. Turn selector switch to **Modem**.
4. Press the **VOTE** button to send results or press screen to exit.

Note: If the above message does not display, consult your modem user manual for the correct INIT string.

4. To complete the modem test, follow the steps listed in the screen message. The terminal displays a message identifying when the test is complete, or if any errors occur. When the modem test is finished, the terminal automatically returns to the Service Menu.

Delivering Terminals to Polling Places

Any voter or supervisor terminal may be used at any polling place. However, care must be taken to deliver the appropriate precinct-specific PEBs (they will be labeled) to the correct polling location, since precinct-specific ballots are contained within them. An easy method to insure correct delivery is including of the PEBs in each precinct official's Election Day instruction package.

Wherever inside and outside temperature differences are extreme (typically northern climates), delivery of equipment should be made at least 24 hours prior to the election. This early delivery allows the equipment to acclimate to room temperature before the polls open.

Chapter 5: Poll Worker Election Day Procedures

Day Procedures

Election Day procedures are very similar for both the Poll Worker Activated System and the Voter Activated System. The steps that follow will indicate which ballot loading system they refer to when the steps differ. The steps should be performed in the sequence that they appear.

Voting Booth Assembly

1. Open the iVotronic voter terminal carrying case and remove the collapsible legs from the lid of the case.
2. Close and latch the case, then turn it over to expose the leg sockets.

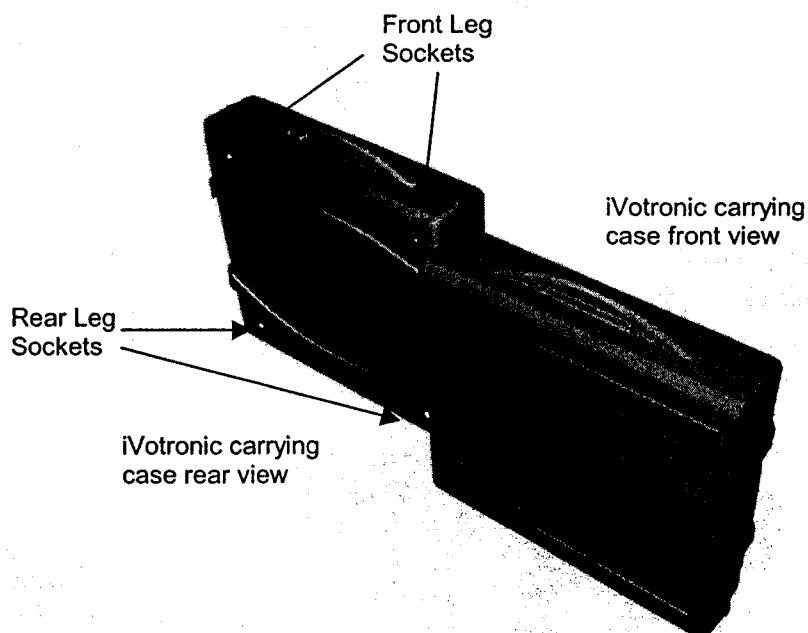

3. Assemble the legs of the iVotronic terminal by pulling the legs apart and inserting the lower halves of the legs into the upper halves.

4. Insert the legs firmly into the leg sockets at the bottom of the case.

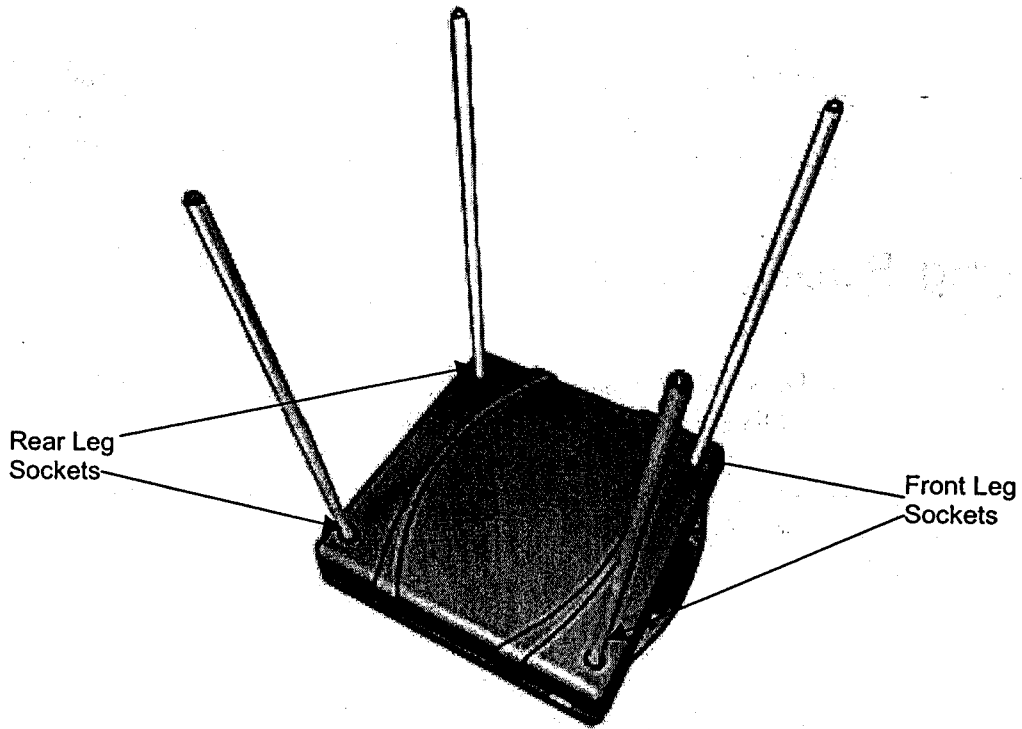

5. Holding the one of the front legs and the case handle, carefully flip the case right-side up and set it on the floor.

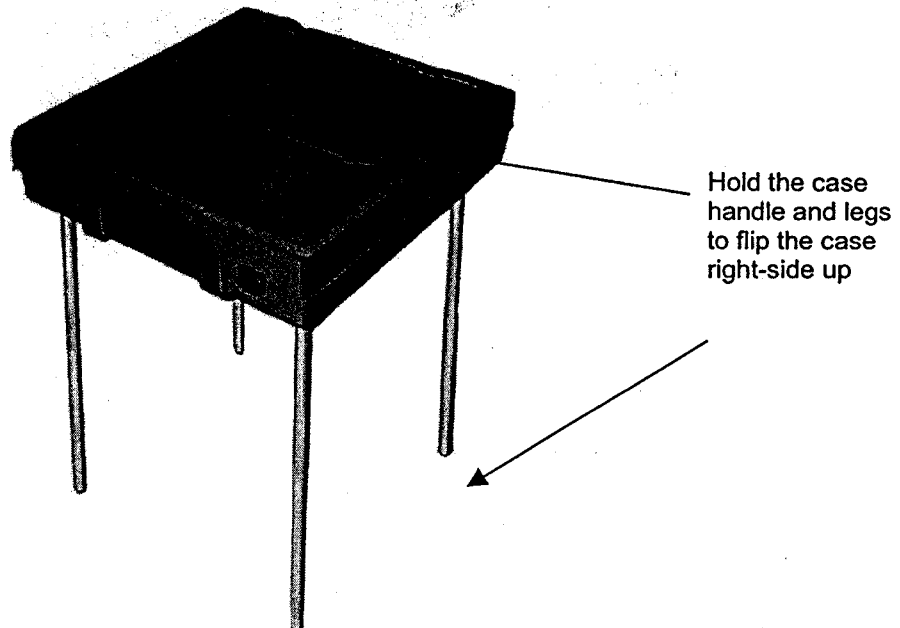

6. Make sure that the iVotronic rests steadily on its legs, then open the case and assemble the privacy screens.

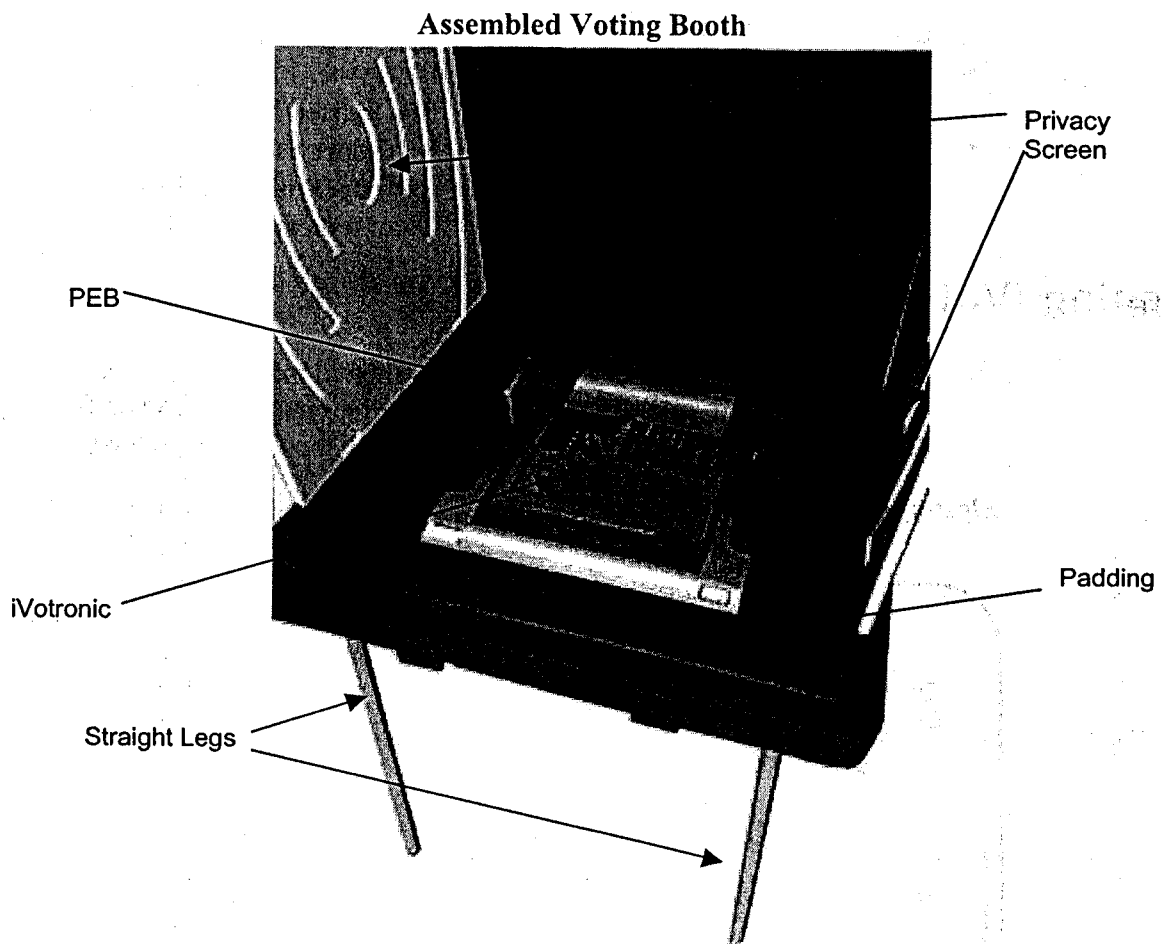

7. Set the booth in desired location. Continue setting up remaining voter booths.

Opening Polling Locations

The equipment at the polling place will vary dependent on which ballot loading system is being used by the jurisdiction.

Poll Worker Activated System:

- Blue voter terminals
- Red master PEB
- Red supervisor PEBs
- Communications pack

Voter Activated System:

- Blue voter terminals
- Blue voter PEBs
- Red master PEB
- Red supervisor PEBs
- Red supervisor terminals
- Communications pack

Opening iVotronic Terminals

1. Open the blue voter terminals by inserting the red master PEB. Upon insertion of the master PEB, all terminals will go through a short self-test (approximately 5 seconds) and then display the following screen:

Election Mode Start-up Screen

SAMPLE PRECINCT

Open terminal now for above named Location.
 Do NOT open terminal.

If this is not the correct polling location,
 Call the Election Office.
 Model I

8:47:22 9/19/2000 Terminal S/N: V002900-6 PEB S/N: PS007191-4
 Software Version 6.1.0 Created 5/2/01 15:23
 Copyright ES&S, Inc. 1993-2000. All Rights Reserved.
 Battery Voltage: 7.28V OK

2. Verify the time and date on the bottom of the voter terminal screen. If the time and date is not correct **do not proceed**; call the election headquarters immediately.
3. Verify the precinct name at the top-center of the screen. If it is not correct, call the election headquarters immediately and choose the **Do NOT open terminal** option.

If the precinct is correct, respond to the message on the screen by selecting the **Open terminal now for above named Precinct** option.

4. Voter terminals in the Poll Worker Activated System will display the message, "Print Zero Tape?" In the Voter Activated System only the supervisor terminal will display the "Print Zero Tape?" message. In either system, press the **No** option unless this is the last terminal being opened, as explained below.
5. Wait for a message that reads "**Please remove PEB, terminal is now OPEN for voting**" and then remove the PEB and proceed to open the remaining terminals. Proceed to step 7 if you are using the Poll Worker Activated System.
6. If you are using the Voter Activated System, open the supervisor terminals after opening all of the voter terminals. Check the precinct name and the time and date before selecting the **Yes** option to open each terminal.
7. When the last terminal is opened (a voter terminal in the Poll Worker Activated System; a supervisor terminal in the Voter Activated System) press the **Yes** option at the "Print Zero Tape?" prompt. Make sure that the last terminal opened is connected to the communications pack and that the switch is turned to Printer. Follow the screen instructions to print the Zero Report.

Note: The Election Administrator may choose to program the election so that printing a zero tape is not an option on the terminal.

Zero Report:

```

cTerminal S/N: S100014-6
PEB S/N PS001062-4
Software Version 6.03
Created 3/7/01 9:12
Copyright ES&S, Inc. 1993-2000
All Rights Reserved
Diagnostic check completed: OK
Votronic II
POLLING LOCATION REPORT
Texas Large Model 2

Total Public Count:                0

Number of Terminals Opened:        1
Individual Voter Terminal Data
S/N V100020
    Public Count:                   0
    Protective Count                 109
    OPENED: 08:49:17 04/05/2001
    NOT CLOSED

*****

PRECINCT: Test Precinct
Public Count                        0
Ballot Style Counts
    Ballot Style #1                 0

```

```

Straight Party
(Vote for 1)
Total:                               0
Rep-Republican                       0 0.00%
Dem-Democratic                       0 0.00%
Lib-Libertarian                      0 0.00%
Soc-Socialist                        0 0.00%

SENATOR
(Vote for 1)
Total:                               0
Rep-JOHN DOE                         0 0.00%
Dem-HARRY SMITH                      0 0.00%
Lib-BOB LILLY                        0 0.00%
Soc-RENEE NEWS                       0 0.00%

>Write-ins in above contest:         0

GOVERNOR
(Vote for 1)
Total:                               0
Rep-JOHN GREEN                       0 0.00%
Dem-HARRY BOX                        0 0.00%
Lib-BOB CARNIS                       0 0.00%

>Write-ins in above contest:         0 0.00%

Time/Date: 08:56:45 04/05/2001

Signature: _____
Signature: _____
Signature: _____

```

Activating the Terminals

The main difference between the Poll Worker Activated System and the Voter Activated System is the method in which the voter terminal is activated for the voter. In the Poll Worker Activated System, a poll worker loads the ballot onto the voter terminal with a red supervisor PEB. In the Voter Activated System, a poll worker loads the ballot onto a blue voter PEB via the red supervisor terminal, and then the voter loads the ballot onto the voter terminal by inserting the voter PEB.

Poll Worker Activated System

1. Verify voter registration. Once verification is complete, the voter may proceed to any available voting booth.
2. Activate the voter terminal by inserting a red supervisor PEB into the terminal PEB slot. If there are multiple ballot choices, they will appear on the ballot selection screen as shown below, and the poll worker should choose the appropriate ballot for the voter. If only one ballot choice is available, it loads automatically.
3. When the ballot is loaded, remove the PEB and step aside so the voter may vote in privacy. Because the activation process takes a very short time (approximately 5 seconds), ES&S recommends that the precinct maintain at least one poll worker with a supervisor PEB for every 2-3 voter terminals being used in the election.

Voter Activated System

1. Verify voter registration by following normal poll procedures.
2. Activate the blue voter PEB by placing it in the red supervisor terminal. If there are multiple ballot choices, they will appear on the ballot selection screen as shown below, and the poll worker should choose the appropriate ballot for the voter. If only one ballot choice is available, it loads automatically.
3. Instruct the voter to take their PEB to the next available voting booth and insert it into the PEB slot. The ballot will load automatically on the voter terminal and the voter may proceed with voting. When finished, the voter will return their voter PEB to poll officials.

Ballot selection screen

PRIMARY ELECTION
May 5, 1996
City of Anywhere, Any State

Coded Ballot

Republican Party - Ward 1
 Democratic Party - Ward 1
 Republican Party - Ward 8
 Democratic Party - Ward 8

After inserting a voter PEB or a supervisor PEB into the voter terminal, the user will be prompted to choose between the Spanish and English version of the ballot if that capability has been programmed into the election definition.

Coding a ballot

If necessary, poll officials may also use the ballot selection screen to attach a specific code to a ballot. After selecting the "Coded Ballot" box, an alphanumeric screen appears for entering the code. Codes allow ballots to be identified in the audit trail (described in Chapter 6) and may be used for provisional ballots.

Voting

Once a ballot has been selected for the voter, the voter terminal reads that ballot from the precinct-specific PEB (supervisor or voter) and displays it to the voter on the screen. Ballots can be displayed in either one or two column format and, depending on the length of the ballot, multiple ballot screens may be used. Specific voting instructions are given in Appendix B (Poll Worker Activated System) and Appendix C (Voter Activated System).

Once the ballot is displayed on a voter terminal, the voter selects a candidate by pressing the candidate's corresponding vote box. When a voter makes a selection in any contest, an X will appear in the selected box and the choice is highlighted in color. This gives the voter an opportunity to verify that the selection has been registered by the iVotronic. The voter may cancel a selection by pressing a box for a second time. When a selection is cancelled, the X disappears and the candidate's name is no longer highlighted. A sample ballot display screen appears below:

Ballot display screen

SAMPLE BALLOT	
For UNITED STATES SENATOR (You May Vote for One)	For GOVERNOR (You May Vote for One)
Tom JEFFERSON.....DEM <input type="checkbox"/>	Jim MADISON.....DEM <input type="checkbox"/>
Vivian LEIGH.....REP <input type="checkbox"/>	Clark GABLE.....REP <input type="checkbox"/>
Write-In <input type="checkbox"/>	Mark McQUIRE.....OTH <input type="checkbox"/>
1. Do you like Major League Baseball?	
YES..... <input type="checkbox"/>	NO..... <input type="checkbox"/>
PREVIOUS PAGE	PAGE 2 OF 3
	NEXT PAGE
Public Count 10	

Automatic Over-Vote Protection

If the voter selects more than the legally allowed number of candidates in a contest, the terminal responds in one of two different ways depending on the "vote for" number in the contest. In a "vote for one" contest, the terminal automatically cancels the voter's first choice when a second choice is made. The terminal will continue to recognize only the voter's last choice, so that only one candidate can ever be selected.

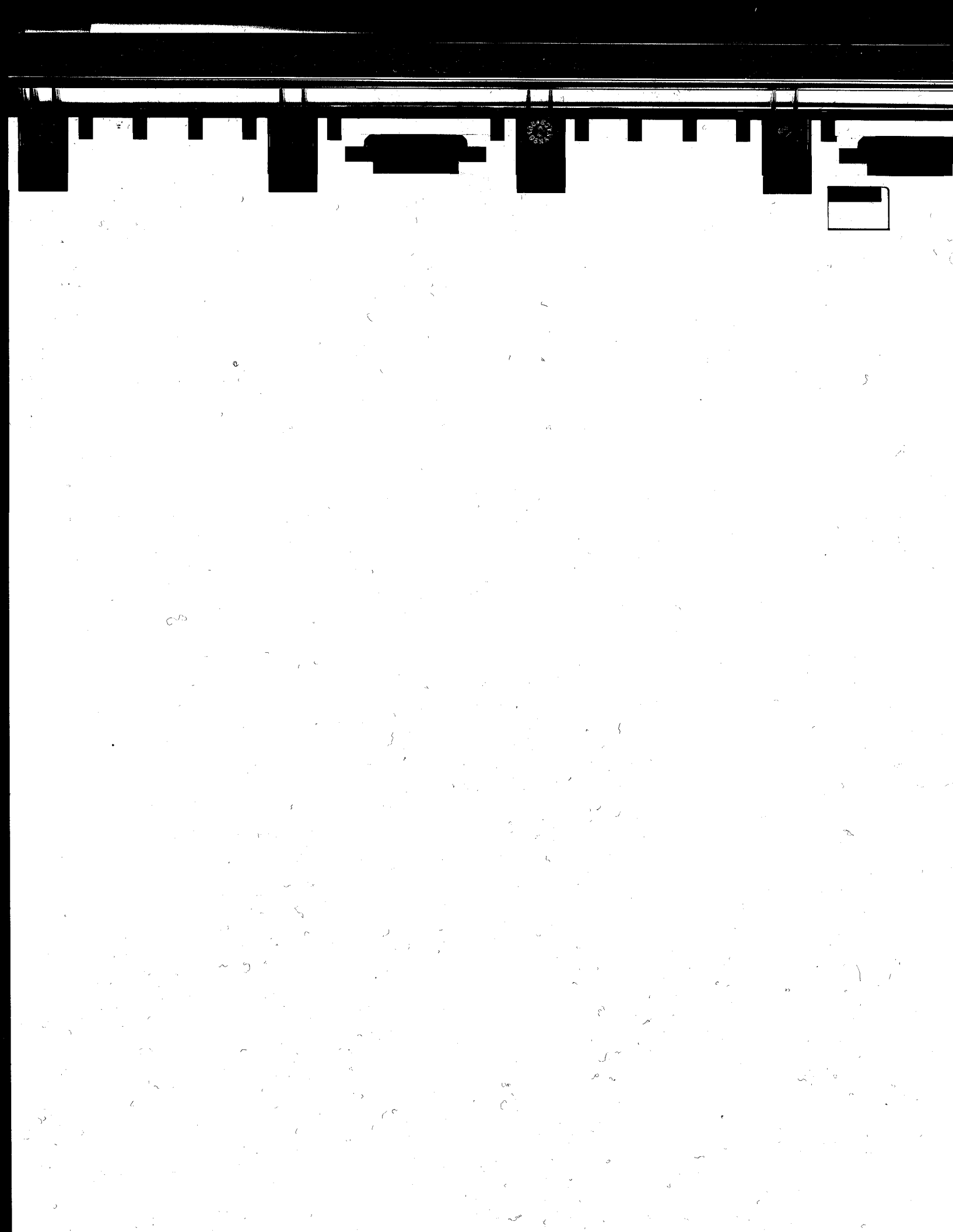

In "vote for more than one" contests, the terminal notifies the voter that the allowed number of selections have already been made, and a selection must be cancelled before a new choice can be made. This message appears every time a voter attempts to over-vote.

Over-vote message screen

You have already selected 2 candidates in this race!

If you wish to select another candidate(s) in this Race you must first deselect a previous selection by pressing the voting stylus in the candidate box(es) which you wish to deselect and make your new selection(s).

Press box at right to continue voting.



If the voter selects a straight party voting option and then attempts to choose a different straight party ballot, all of the candidates selected when the first straight party vote was made are automatically cancelled. The candidates representing the second straight party selection are then highlighted.

If a voter chooses to vote straight party, then, in a "vote for more than one" race decides to select a candidate from a different party, all straight party candidate selections within the current race are automatically cancelled. The voter must manually cast votes for that specific race, but the rest of the straight party ballot will remain unchanged.

The Write-In Vote

If a voter selects the box for a "write-in" candidate, the Write-In Vote screen automatically displays.

Write-In Vote Screen

Write-In Vote Screen

A	B	C	D	E	F	G	H	I	J	K	L	
M	N	O	P	Q	R	S	T	U	V	W	Y	X
Y	Z	0	1	2	3	4	5	6	7	8	9	
. . -		(SPACE) (BACKSPACE)										

>>Accept<< >>Cancel<<

Press letters, (SPACE), and numbers as desired.
Press (BACKSPACE) to remove mistakes.
Press Accept or Cancel when you are done.

This screen allows the voter to press letters and numbers to spell out the desired candidate's name and address if required. Once the voter finishes selecting the desired text and presses Accept, the ballot reappears. The text the voter entered is highlighted in place of the Write-In label and an X is placed in the vote box. The information entered by the voter will appear exactly as if it had been selected from the existing candidate list for this contest.

To cancel a Write-In selection, press the corresponding vote box a second time. The "Write-In" text is removed and the "Write-In" label reappears in its original position. The voter may then vote for another candidate, or press the Write-In vote box again to select another Write-In candidate.

Viewing All Pages

Voter terminals require the voter to "at least view" all ballot pages before the ballot is cast, but he/she does not have to cast a vote unless the ballot is programmed for that option. The requirement to view all pages helps prevent ballot fall-off and accidental early casting of the ballot. If the voter presses the VOTE button before viewing the last ballot page, the voter terminal displays the message, "You must view all pages before casting your vote." A prompt will ask the voter to acknowledge the message by pressing inside the box on the screen. The iVotronic then redisplay the ballot as the voter left it. The VOTE button will not activate until the last page has been viewed.

View all pages notification screen

You must view all pages before casting your vote.

Press box at the right to continue voting.

Summary Review Ballot

The last page to be viewed is a summary of the candidate selections made by the voter. A sample of this page is shown below:

Instructions to Voter	
Press the red VOTE button to cast your ballot ONLY after completing your selections To edit any of your contest selections, press the box next to the contest you wish to edit	
For President..... <input type="checkbox"/> John Doe	For President..... <input type="checkbox"/> John Doe
For City Council..... <input type="checkbox"/> Vote for not more than 4 2 Candidates Selected	For City Council..... <input type="checkbox"/> Vote for not more than 4 2 Candidates Selected
For Dog Catcher..... <input type="checkbox"/> No Candidate Selected	For Dog Catcher..... <input type="checkbox"/> No Candidate Selected
For School Council..... <input type="checkbox"/> Vote for not more than 5 No Candidate Selected	For School Council..... <input type="checkbox"/> Vote for not more than 5 No Candidate Selected
For President..... <input type="checkbox"/> John Doe	For President..... <input type="checkbox"/> John Doe
For City Council..... <input type="checkbox"/> Vote for not more than 4 2 Candidates Selected	For City Council..... <input type="checkbox"/> Vote for not more than 4 2 Candidates Selected
For Dog Catcher..... <input type="checkbox"/> No Candidate Selected	For Dog Catcher..... <input type="checkbox"/> No Candidate Selected
Summary Ballot Page 1 of 2	

The review ballot allows the voter to change a previous selection by choosing the contest that they want to change. A screen showing only that contest will appear, and new candidate choices can be made. The new choice will be shown on the review ballot immediately. Once a voter has viewed the entire summary review ballot page, they can cast the ballot at any time by pressing the VOTE button.

Note: The summary review ballot option may be turned off in the election definition.

The VOTE Button

The Election Administrator has the option of programming the iVotronic to accept a ballot without any votes cast. If this is the case, the ballot will automatically be cast after the VOTE button has been pressed.

If the Election Administrator chooses to ensure every ballot has at least one vote cast, the following message will appear if the voter has viewed all pages without casting a vote, and then presses the VOTE button:

You must select at least one candidate before casting your ballot.

Press box at the right to continue voting.



The voter may select the "Previous Page" box to review or alter selections. Once the VOTE button is activated, the ballot may be cast while any page is being viewed, except the Write-In screen where the VOTE button is temporarily disabled.

If all pages have been viewed and at least one candidate has been selected, the VOTE button will illuminate. Once the voter has viewed all pages and made all the desired selections, pressing the VOTE button casts the ballot.

Once the ballot has been properly voted and the VOTE button is pressed, the display screen will display the message shown below. The terminal then powers down automatically. For each ballot cast, the public count is increased incrementally.

Please Wait: Recording Your Vote....

Thank You for Voting.

Casting a Ballot for a Voter

Theoretically, a forgetful or unaware voter could remove the voter PEB from the voter terminal (Voter Activated System) or simply walk away (Poll Worker Activated System) before pressing the VOTE button to cast their ballot. If this situation occurs, an alarm sounds. This alarm is a normal function of the voter terminal, which indicates an incomplete function remains on the terminal. The alarm sounds immediately-upon removal of the voter PEB in the Voter Activated System, and after 10 minutes of inactivity in the Poll Worker Activated System. The alarm discourages other voters from using the voter terminal until the original voter returns, or an election official takes action to alleviate the situation.

In the Poll Worker Activated System, the screen displays the message, "You have not cast your ballot." Then the screen displays "Last ballot was not cast" and gives you two options; "Cast Ballot" or "Cancel Ballot." In the Voter Activated System, the screen also displays a message, "You have not cast your vote. Please reinsert your ballot now."

Usually, the audible alarm and the message on the screen will alert the original voter to the situation who will reinsert the voter PEB, which displays the ballot exactly as they left it. Then, the voter may continue to vote normally. However, the possibility exists that the voter may not notice the message on the screen or the audible alarm. The voter may even leave the polling place quickly before anyone notices the alarm, particularly in the Poll Worker Activated System.

When an election official hears an alarm, they have three options:

- Cast the ballot as the voter left it,
- Cancel the ballot (not incrementing any terminal counters), or
- Cast a blank ballot.

Please consult the Election Administrator for the correct course of action for your precinct.

Casting a Ballot as Voted

1. Either reinsert the same voter PEB (Voter Activated System) or simply press the screen (Poll Worker Activated System).
2. Then press the illuminated **VOTE** button.

Cancelling a Ballot or Casting a Blank Ballot

1. Insert the master PEB (Voter Activated System) or supervisor PEB (Voter Activated System). In both ballot loading systems, the ballot will not redisplay.
2. Instead, the screen displays the following message: "**Cast Ballot**" or "**Cancel Ballot.**" The official should make the appropriate selection.
3. Next, the screen asks if you would like to complete the function. Select **Yes** to complete, or **No** to return to the original screen.

Note: Casting a blank ballot (i.e., no votes selected) in this fashion is the only method of recording a protest vote. Casting a blank ballot increments the public and protective counters, but no candidate counters. Canceling a ballot does not increment any of the terminal counters; the Protective Counter, the Public Counter, or the Candidate Counter.

Closing Polls

Closing a Terminal Early

When opening the polls, the red master PEB programs each voter terminal with the correct poll closing time. The polls can not be closed without an override password until the voter terminal's internal real time clock recognizes the current time as the correct closing time.

1. In a Voter Activated System insert the red master PEB into the terminal. The terminal will display the message "Do you want to close this terminal?"

In the Poll Worker Activated System insert the red master PEB into the terminal while pressing the screen. Continue to press the screen until the terminal displays the message "Do you want to close this terminal?"

2. Select **Yes** to close the terminal. The terminal will display the message "Collecting Votes." If it is not yet the minimum closing time the terminal then displays the screen below.

Early Poll Closing Screen

It is too early to close.

Override Now
 Postpone until later

8:47:22 9/19/2000 Terminal S/N: V002900-6 PEB S/N: PS007191-4
 Software Version 6.1.0 Created 5/2/01 15:23
 Copyright ES&S, Inc. 1993-2000. All Rights Reserved.

Battery Voltage: 7.26V OK

3. Select **Override Now** and the Override Password screen will appear.

Override Password Screen

Please enter Override Password

A	B	C	D	E	F	G	H	I	J	K	L	
M	N	O	P	Q	R	S	T	U	V	W	Y	X
Y	Z	0	1	2	3	4	5	6	7	8	9	

.. - (SPACE) (BACKSPACE)

>>Accept<< >>Cancel<<

Press letters, (SPACE) and numbers as desired,
 Press (BACKSPACE) to remove mistakes.
 Press Accept or Cancel box when you are done.

4. Enter the override password. If the password is not entered properly, the voter terminal will not close. After the correct password is entered the terminal will display the message "Collecting Votes," and then the message "Please remove PEB, votes collected."

Note: The Override Password option is programmable for each election and can be obtained from the Election Administrator.

Closing Terminals at the Official Time

1. Close the voter terminals by inserting the red master PEB into the PEB slot. Once the time is synchronized, the voter terminal displays the following message upon insertion of any PEB: **“Do you want to close this terminal?”**

Close Terminal Screen

Do you want to close this terminal?

Yes
 No

8:47:22 9/19/2000 Terminal S/N: V002900-6 PEB S/N: PS007191-4
Software Version 6.1.0 Created 5/2/01 15:23
Copyright ES&S, Inc. 1993-2000. All Rights Reserved.

Battery Voltage: 7.26V OK

2. If all voters have finished voting, select **Yes** and proceed to the next step. If voters are still waiting to vote, select **No** and load the ballot. When the precinct official selects **Yes** to close a voter terminal, the terminal displays the following screen message: **“Collecting Votes to PEB. Please Wait... You will be notified at completion.”**
3. The terminal will automatically copy its vote totals from memory onto the polling location master PEB. The terminal also copies its Public Count, serial number, and the opening/closing time and date onto the polling location's master PEB. All voter terminals are closed in the same manner. Do not remove the master PEB until a message appears indicating all votes have been collected. The message will read, **“Please remove ballot, votes collected.”**
4. Remove the master PEB and continue closing the remaining voter terminals.
5. If the Voter Activated System is being used, close all voter terminals, then close the supervisor terminal in the same manner as the voter terminals were closed. A message will display indicating **“Closed Supervisor Terminal.”** The terminal will then display a message asking **“Modem Results Now?”** See the following section for modem instructions.

Once a voter terminal is closed and the vote totals have been copied onto the master PEB, the voter terminal can no longer be used for voting. Typically, closing the polls ends the voter terminal activity for the

election. However, terminals can be referenced in the future for recollecting votes and copying audit trail information.

Note: The master PEB retains a record of all opened voter terminals by their serial number. Polling location results cannot be printed or transferred via modem until all open terminals have been closed and their votes collected.

Modeming Results

1. Once the votes from ALL of the voter terminals have been collected on the master PEB, connect the Communications Pack to the back of a closed voter terminal (Poll Worker Activated System), or to the back of a closed supervisor terminal (Voter Activated System).
2. Turn the selector switch on the pack to **Modem** and insert the master PEB. The terminal will display the message: "Modem precinct totals now?" In the Voter Activated System this message will have appeared already, when the supervisor terminal was closed.

Note: If all opened voter terminals are not closed, the user will be instructed to close those serial numbers before transferring results.

3. Press **Yes** and the following screen appears:

Modem Instruction Screen

1. Make sure the Communications Pack is connected to the back of voting terminal.
2. Plug phone line into jack on Selection Box.
3. Turn selector switch to Modem.
4. Press the **VOTE** button to send results or press screen to exit

4. Follow the screen instructions. Press the **VOTE** button and the modem immediately dials the preprogrammed number and sends the results. The unit informs the user if the upload is successful.
5. If the upload was not successful, the terminal will ask "Try Again?" The user may try repeatedly to modem. If the upload is successful, the user presses the screen to continue to the print results screen.

If the data transfer is unsuccessful after several tries, the user may press No when prompted with the question "Try Again?" and continue by printing the results tapes.

Note: If a jurisdiction chooses not to program the election with modem capabilities, none of the above modem instruction screens will appear.

Printing Results

1. After data transfer is complete, a message will prompt the user: "Print Results now?" If modeming results was not an option programmed for the election, insert the master PEB into the last voter terminal closed (Poll Worker Activated System) or the last supervisor terminal closed (Voter Activated System) and the "Print Results now?" prompt will appear.

Print Precinct Results Screen

Print totals now?

Yes
 No

8:47:22 9/19/2000 Terminal S/N: V002900-6 PEB S/N: PS007191-4
Software Version 6.1.0 Created 5/2/01 15:23
Copyright ES&S, Inc. 1993-2000. All Rights Reserved.

Battery Voltage: 7.26V OK

2. Select Yes and a second message screen will appear:

Print Instruction Screen

1. **Make sure the communication pack is connected to the back of the voting terminal.**
2. **Turn the selector switch to PRINTER.**
3. **Press and hold the small black button on the printer until its green light turns on.**
4. **Press the VOTE button to print report if desired or press screen to exit.**

3. Press the red **VOTE** button, printing should begin immediately. After the programmed number of tapes have been printed, the user will be asked, "Do you want to print another tape?"
4. Select **Yes** to print another tape, as many times as needed.
5. To complete the printing process, respond **No** when asked to print another tape.
6. The terminal will prompt you to turn off the Communications Pack. Press the screen to continue.
7. In the Poll Worker Activated System, remove the PEB when the message "Do you want to re-collect this terminal?" appears. In the Voter Activated System, remove the PEB after responding "No" to the "Do you want to print another tape" prompt.

Printing Report to Screen

If necessary, you can print results to the screen from the Election Central Applications menu. This allows the user to view the report format on the screen instead of waiting for the printed report or uploading the data to a PC. The terminal displays the report on the screen one page at a time. The user can press the screen with the attached stylus to advance the report pages. When the report ends, execution returns to the ECA menu.

Printing Report to Printer

This option can be used to print a report from the ECA menu. After selecting the **Print Report to Printer** option, the terminal will display printing instructions and the user can press the **VOTE** button to print.

Note: Supervisor Terminals will display the printout from the last PEB that was accessed into memory. To ensure that the printout is correct for the PEB currently inserted, let the terminal access the PEB in the Election Mode as if you were going to open the polls first. Then, go into the service menu with that PEB and print the report.

Sample Precinct Results Tape

```

Terminal S/N: S100014-6
PEB S/N: PS001062-4
Software Version 6.03
Created 3/7/01 9:12
Copyright ES&S, Inc. 1993-2000
All Rights Reserved
Diagnostic check completed: OK
Votronic II
POLLING LOCATION REPORT
Texas Large Model 2

Total Public Count:                7

Number of Terminals Opened:        1
Individual Voter Terminal Data
  S/N V100020
    Public Count:                   7
    Protective Count:               116
    OPENED: 08:49:17 04/05/2001
    CLOSED: 10:25:02 04/05/2001
    Coded Ballot Count:             0

*****
PRECINCT: Test Precinct
Public Count:                       7
Ballot Style Counts
  Ballot Style #1                   7
    
```

```

Straight Ticket Counts
  Republican                        1
  Democratic                         1
  Libertarian                        0
  Socialist                          0

Straight Party
  (Vote for 1)
  Rep-Republican                     1  33.33%
  Dem-Democratic                     2  66.66%
  Lib-Libertarian                    0  0.00%
  Soc-Socialist                      0  0.00%
  Total:                             3

SENATOR
  (Vote for 1)
  Rep-JOHN DOE                       3  50.00%
  Dem-HARRY SMITH                    2  33.33%
  Lib-BOB LILLY                      0  0.00%
  Soc-RENEE NEWS                     1  16.66%
  Total:                             6

SCHOOL BOARD DIRECTOR
  (Vote for 3)
  JOHN COLEMAN                       3  30.00%
  HARRY BASTROP                      1  10.00%
  BOB BELL                           1  10.00%
  RENEE BAYLOR                       0  0.00%
  DORIS BAILEY                      1  10.00%
  TRAVIS AUSTIN                      2  20.00%
  Total:                             10

>ALLEN MURPHY
>ROSIE DOUGLAS
>Write-ins in above contest:        2

Time/Date: 10:38:49 04/05/2001

Signature: _____
Signature: _____
Signature: _____
    
```

Closing Polling Location

1. Ensure all votes have been collected and all results have been printed.
2. Disassemble voting booths.
3. Ensure Communications Pack Selector switch is in the **OFF** position.
Close and latch the Communications Pack.
4. Transport voting equipment to instructed location.
5. Take the master PEB to the Election Administrator (usually located at election headquarters).

Chapter 6: Post-Election Tasks

Post-Election tasks include:

- Additional reporting.
- Recounting votes if required by various circumstances.
- Collecting the audit data from voter terminals.
- Storing and cleaning the iVotronic equipment.

Reporting Combined Polling Location Results

When all polls are closed and each master PEB has been returned to election headquarters each polling location's results are combined for reporting purposes. A PEB reader can be used with Election Reporting Manager software to combine results, or the upload PEB Vote Results option on the Election Central Applications menu can be used to combine the results.

Uploading PEB Vote Results from Supervisor Terminal

This selection transfers a polling location's election vote totals from the master PEB via a supervisor terminal to a connected IBM-compatible PC. The uploaded data is not in report format. Rather, it is an ASCII text listing of counter numbers, and the number of votes stored in each counter. The PC should be running Election Reporting Manager software, which will convert the data to a report format. Election data can be stored indefinitely on the computer or on computer disks.

No communications link exists between the iVotronic supervisor terminal and the IBM-compatible PC. The computer must be ready to accept the data before selecting the "Upload PEB Vote Results" option from the ECA Menu. The terminal returns to the ECA Menu when the upload is completed.

1. Insert the first master PEB into the iVotronic supervisor terminal.
2. Bring up the Elections Central Application menu and select **Upload PEB Vote Results**.

The following message appears on the terminal screen:

- Connect the serial cable to the PC
 - Prepare PC to Upload PEB Vote Results
 - Press Vote button to Proceed with Upload
 - Or Press screen to skip Upload
3. Connect the supervisor terminal to the PC by plugging one end of the serial cable into the back of the iVotronic and the other end into a COM port on the computer.
 4. Prepare the computer by selecting the **Process PEBs** option on the Tabulator menu in the Election Reporting Manager Software. The Process PEBs window appears. Choose the **iVotronic** option and **Supervisor terminal** then choose **OK**. Specify the **COM port** you are using in the drop down box that appears, and then select **OK**.
 5. Click **OK** when the message "Click OK to Read PEB, else click Cancel" appears on the computer screen. The computer screen will display a message saying, "Please wait for processing to complete."
 6. Press the **VOTE** button on the iVotronic terminal.

The iVotronic terminal will display the message "Upload completed successfully. Please Remove PEB."

The upload process is complete when the computer displays the message "PEB votes retrieved for P0004002, SPP file record created for P0004002." Click **OK**.

The computer will display the message "Click OK to Read PEB, else click Cancel. Steps 1-2 and 5-6 should be repeated for each master PEB.

7. Consult the Election Reporting Manager manual for instructions on consolidating and printing the PEB Vote results.

Uploading Vote Results from PEB Reader

1. Connect PEB reader to PC by attaching the cable to a COM port on the computer.
2. Insert the first master PEB into the PEB reader.
3. Prepare the computer by selecting the **Process PEBs** option on the Tabulator menu in the Election Reporting Manager Software. The Process PEBs window appears. Choose the **iVotronic** option and the **PEB Reader** option then choose **OK**. Specify the **COM** port you are using in the drop down box that appears, and then select **OK**.
4. Click **OK** when the message "Click OK to Read PEB, else Click Cancel" appears on the computer screen. The computer screen will display a message saying, "Please wait for processing to complete."
5. The upload process is complete when the computer displays the message "PEB votes retrieved for P0004002, SPP file record created for P0004002." Click **OK**.

The computer will display the message "Click OK to Read PEB, else click Cancel. Steps 2, 4, and 5 should be repeated for each master PEB.

6. After all master PEBs are uploaded consult the Election Reporting Manager Manual to update and print the precinct results.

Recollecting Votes for a Recount

Some situations may arise when a recount is necessary. The iVotronic Voting System design makes this recount a simple procedure, as long as the equipment has not been prepared for another election (i.e., cleared and tested terminals and qualified supervisor PEBs). Take the following steps to perform a recount on the iVotronic terminals.

Collecting Votes from Voter Terminals

The master or supervisor PEBs that were originally used at a polling location must be reused to recollect the votes from that location's voter terminals. The ballot formats must match. The voter terminals will not allow votes to be recollecting to a master or supervisor PEB with different ballot formats.

ES&S recommends that officials using the Poll Worker Activated System use a supervisor PEB from the same polling location for vote collection. Officials using the Voter Activated System should use a spare supervisor PEB if it is available, otherwise they should clear vote totals out of the master PEB and reuse it for vote recollection.

1. Recharge terminal batteries, and replace Communication Pack batteries if necessary.
2. If your election jurisdiction is using the Voter Activated System and the master PEB to recollect the votes, access the **Service menu** on a supervisor terminal, and then select the **Election Central Applications menu**. Select **Clear Supervisor PEB Vote Totals** to clear vote totals from the master PEB.
3. If your election jurisdiction is using the Poll Worker Activated System, insert a supervisor PEB into a voter terminal. The terminal will prompt the user to "Print totals now?" Select the **No** option.

If your election jurisdiction is using the Voter Activated System and a master PEB to recollect the votes, insert the master PEB into the voter terminal. You will not be prompted to "Print totals now?"

4. In both systems, the next prompt asks, "Do you want to recollect this terminal?" Select the **Yes** option and wait for the message that indicates all votes have been recollected. Remove the PEB.
5. Repeat the above step for *every* voter terminal used at the polling location. Because the master PEB was emptied of all voter terminal data, it will not recognize if any voter terminals that were originally used in the election are not recollected. However, the printed report and the uploaded data will accurately report the serial numbers and data from each recollected voter terminal for comparison purposes.
6. Repeat the above steps for each polling location.
7. Modem, print, and combine results as you would normally.

Note: If a hand count is required, audit data must be collected, converted, and then each ballot printed and counted.

Retrieving Audit Information

Randomized Audit Trail

During the voting process, the iVotronic equipment creates an audit trail consisting of an event log and ballot images. The event log consists of three separate portions, which are terminal information, PEB records, and event records. The terminals also record audit data in the form of ballot images as they were cast and ballot codes (if entered by the precinct official). This method of ballot image storage and retrieval comprises the randomized audit trail feature.

In the terminals, the ballot image data is recorded randomly (according to a rolling milliseconds timer), making it impossible to trace any voted ballot back to a particular voter, unless the ballot was previously coded by the precinct official. This preserves voter anonymity.

Closing the voter terminals at the end of the Election Day only collects the candidate numbers and the number of votes that each candidate received. The complete ballot images and event log (audit data) are not included in the polling location results reported on Election Day.

Audit data should be retrieved from all voter terminals after each election. When the terminals are cleared and tested for the next election all audit data will be lost. The audit data uploads to the PC in a format similar to the "Upload PEB Vote Results" selection from the ECA Menu. A conversion file then converts the audit data into a readable text format. Audit data is retrieved using the following options on the Election Central Application menu.

Preparing PEB for Serial Audit

The "Prepare PEB for Serial Audit" option from the ECA Menu encodes a supervisor PEB (without voter totals) with instructions so that the voter terminals can copy all of their audit data directly to a PC. The computer must be ready to accept the data (running Election Reporting Manager and selecting specific menu items) before pressing YES to begin uploading. Each terminal from which audit data is being collected will need to be connected to the PC when using this option.

Note: Once you have selected Prepare PEB for Serial Audit, you will no longer be able to view the ballot on that PEB.

Collecting Audit Data with Prepared PEB

When inserted, the "Prepared" PEB automatically instructs the voter terminal to copy its data without affecting the safety or integrity of the stored audit data. By using a "Prepared PEB" the user does not have to go through the Service menu and ECA menu and passwords. The data uploads automatically to the PC. This process takes between one to four minutes, depending on the size and number of ballots cast on the voter terminal.

Uploading Terminal Audit Data

This option is only displayed from the ECA menu on a Voter Terminal and is used to upload audit data directly from a voter terminal to a PC. The PC must be ready to receive the audit data by having Election Reporting Manager software running.

1. Insert a supervisor PEB into the iVotronic voter terminal.
2. Bring up the Elections Central Application menu and select **Upload Terminal Audit Data**.

The following message appears on the terminal screen:

- Connect the serial cable to the PC
 - Prepare PC to accept Audit Trail Data Upload
 - Press Vote button to Proceed with Upload
 - Or Press screen to skip Upload
3. Connect the voter terminal to the PC by plugging one end of the serial cable into the back of the iVotronic and the other end into a COM port on the computer.
 4. Prepare the computer by selecting the **Collect Audit Data** option on the Tabulator menu in the Election Reporting Manager Software. The Collect Audit Data window appears. Click the **Include Coded Ballots** box if you want ballots that were coded to be included. Specify the **COM port** you are using in the drop down box that appears and select **OK**.
 5. Click **OK** when the message "Click OK to Collect Audit Data, else click Cancel" appears on the computer screen. The computer screen will display a message saying, "Please wait for processing to complete."

6. Press the **VOTE** button on the iVotronic terminal.

The iVotronic terminal will display the message "Upload completed successfully. Please Remove PEB."

The upload process is complete when the computer displays the message "Audit Data Collected for V010015, V01005 SPV file created." Click **OK**.

The computer will display the message "Click OK to Collect Audit Data, else click Cancel." The remaining terminals can be connected to the computer and the audit data uploaded from this screen (Complete steps 1-3, and 5-6 for each terminal).

7. Consult the Election Reporting Manager manual for instructions on consolidating and printing the audit results.

Storing the iVotronic

Before storing the iVotronic, it may be cleaned with glass cleaner and a soft cloth. Batteries should be removed from all Communications packs. The iVotronics can be stacked up to ten high, both in and out of their cases. Storage should be in a dry, indoor facility with a temperature range of 0-120 degrees Fahrenheit and 95% non-condensing humidity. However, ES&S recommends that the iVotronic components be stored in a climate controlled environment. Climate controlled storage will reduce wear and tear and extend the life of the electronic components of the iVotronic.

Faint, illegible text at the top of the page, possibly a header or introductory paragraph.

Main body of faint, illegible text, appearing to be several paragraphs of a document.

Bottom section of faint, illegible text, possibly a conclusion or a separate section.

Chapter 7: Election Specific Capabilities and Safeguards

The iVotronic can be programmed for a variety of election types and different counting requirements that vary from state to state. These election capabilities are described below.

Election Capabilities

Partisan and Nonpartisan Contests

Within an election, some contests are partisan contests and some contests are not. The iVotronic Voting System supports both types of contests.

The Election Administrator decides on the election definition. There are several options; the partisan contests may or may not be subject to the Straight Party option, the nonpartisan candidates may or may not show their party affiliation beside their names.

Straight Party Voting

The iVotronic Voting System employs the Pennsylvania Straight Party method for responding to voter straight party selections. Up to 10 separate parties may be represented for straight party voting.

When a straight party option is selected, the terminal automatically highlights all candidates representing the chosen party in partisan contests. When the voter cancels a straight party option, all candidates that were automatically selected are automatically canceled.

Straight Party Reporting

The polling location results report also includes the number of ballots that were voted strictly straight party when the voter selected *ONLY* the straight party option for all partisan contests. If the voter "Crossed Over" (see the Crossover Contests section in this manual) any of the partisan

contests on the ballot, that voter's ballot will not increment the number of straight party votes reported in the polling location results. Even if the voter changes all of the "Crossed Over" contests back to the original party, that ballot will not be reported as a Straight Party Ballot.

Voter activity in nonpartisan contests has no effect on the calculations for the number of straight party ballots that were cast.

Crossover Contests

In accordance with the Pennsylvania Straight Party method, if a voter selects a straight party option, proceeds to a partisan contest, and manually selects a candidate of a different party, the previously selected Straight Party candidate in that contest automatically cancels for the voter. The iVotronic views this contest as a "Crossover" contest with respect to straight party voting. The selection or cancellation of a straight party option by the voter never affects the selections made in a "Crossover" contest in any way. If the voter manually cancels a "Crossover" vote in a contest and leaves no candidate selected, the contest no longer constitutes a "Crossover" and the ballot will be included with the straight party vote totals.

Voter activity in nonpartisan contests has no effect on straight party voting, and straight party voting has no effect on nonpartisan contests.

Propositions

The iVotronic Voting System treats propositions as contests that have candidates named "Yes" and "No" or "For" and "Against." The usual rules for selections and cancellations apply to propositions. Although propositions are usually nonpartisan, the iVotronic can allow them to be voted as partisan contests if the need arises.

Primaries and Split Precincts

For most jurisdictions, the iVotronic Voting System supports primary elections and split precincts in the same fashion. In both cases, the voter declares to the precinct official which ballot will be used, and the precinct official selects the appropriate ballot for the voter.

In the Poll Worker Activated System, this selection occurs at the voter terminal. In the Voter Activated System, it occurs at the supervisor

terminal. The selected ballot loads into a voter terminal or PEB respectively, and the voter votes in the same manner as a general election. The ballots on the supervisor terminal or supervisor PEB are named appropriately, so they are easily identified by party and/or precinct.

Just as in the general election, the ballots may or may not contain nonpartisan contests. A single precinct report still produces all the election results within a split precinct or primary election.

Pick Your Party Primary

Some jurisdictions have requirements that allow the voter to select which party they want to vote, without declaring their preference to the precinct official. This is known as a Pick Your Party primary. The iVotronic allows for a Pick Your Party primary via ES&S ballot programming.

Loading the PEB

In a Pick Your Party primary election, precincts need to supply all party ballots to every voter. Loading the voter PEB or terminal with a ballot for every party in the election fulfills this need.

When the voter terminal activates, the terminal displays a party selection screen that allows a voter to select a particular party's ballot, or browse through all of the ballots. In a split precinct, precinct officials still need to select the appropriate precinct ballot before the display of the party selection screen.

Locking in a Ballot

When the voter selects one of the ballots, the ballot displays for voting. Once the voter makes candidate selections on that ballot, the voter is locked into that ballot, and voting procedures become identical to those in a general election. If the voter tries to page back to the ballot selection screen, a message will appear informing the voter that all candidate selections must be manually deselected before the terminal grants access to the ballot selection screen. However, if the voter has not selected any candidates while paging through the selected ballot, or if the voter has selected candidates but then deselected all of them, the voter may page back to the ballot selection screen. The voter may then select the same party ballot, select the ballot of a different party, or select the browse all ballots option.

Browsing All Ballots

Once the voter selects the "Browse All Ballots" option, they will not be able to return to the party ballot selection screen and the iVotronic displays the first page of the first party ballot listed. The voter may page through that ballot to the last page.

If the voter has not selected any candidates on the first ballot, then the first page of the second ballot appears when the Next Page option is selected. The voter may then page through the new ballot to the last page, and so on. When the voter reaches the last page of the last party ballot and the Next Page option is selected, the first page of the first party ballot appears again for voting.

This sequence may continue as long as the voter does not select any candidates on any of the party ballots. Once the voter selects a candidate, they are locked into that party ballot. However, the voter may regain access to other party ballots by manually canceling all candidate selections.

When the voter reaches the last page of a ballot with selected candidates, the VOTE button illuminates. The voter may then cast the party ballot by pressing the illuminated VOTE button.

Note: If the voter chooses to vote straight-party, he or she will be given an option of bypassing all pages that have straight party races. If the entire ballot is straight party, the system will default to the last page of the ballot, allowing the voter to cast a ballot without scrolling through each page of the ballot.

Undecided Voter Primary

In some state primary elections, it is legal for the voter to stop voting on one primary ballot and request a ballot from another party. Even those ballots that include candidate selections may be traded in for another ballot. The iVotronic Voting System supports this type of primary election.

In the Poll Worker Activated System, the undecided voter calls an election official over to their voter terminal, and the official reinserts a supervisor PEB, which allows the ballot to be canceled. In the Voter Activated System, the voter removes their voter PEB and returns it to the precinct official for reloading with a second ballot.

When the voter removes the PEB from the voter terminal, an alarm sounds and the screen displays the message, "You have not cast your vote. Please

reinsert your PEB now.” This alarm is typical for the voter terminal because an incomplete terminal function has occurred. The alarm discourages other voters from using the voter terminal until the original voter returns, and the voter terminal will not respond to a different voter PEB with a different serial number.

After loading a second PEB with a ballot for the undecided voter, the precinct official must take a supervisor PEB back to the voter terminal and insert it. The official can then cancel the ballot without incrementing the any of the counters; the Protective Counter, the Public Counter, or the Candidate Counters.

After canceling the first ballot in either ballot loading system, the precinct official should remove the PEB allowing the voter terminal to power down. The voter can then use any open voter terminal, including the one the precinct official has just canceled, to vote the second ballot. The iVotronic allows for this process to continue as long as the VOTE button has not been pressed to cast the ballot.

Election Capabilities Upgrades

When election requirements change, the iVotronic can adapt to those changes by uploading new firmware. The iVotronic terminals are updated by inserting a compact flash card and choosing the **Upload Firmware** option on the **Election Central Applications Menu**. Only ES&S personnel should upload firmware.

General Safeguards

The iVotronic Voting System offers built-in safeguards to protect the voting process and ensure a valid election. The safeguards detailed in this section are:

- Randomized Audit Trail
- Protection Against Fraud.
- Protection Against Over-voting.
- Protection Against Power Drain.
- Protecting the Ballot Format.
- Redundancy.
- Protection Against Malicious Vote Fraud.

Randomized Audit Trail

During the voting process, the iVotronic equipment creates an audit trail. Not only does each voter terminal retain all votes cast on it; the terminals also record audit data in the form of ballot images as they were cast and ballot codes (if entered by the precinct official). This method of ballot image storage and retrieval comprises the Randomized audit trail feature.

In the terminals, the audit data is recorded randomly (according to a rolling milliseconds timer), making it impossible to trace any voted ballot back to a particular voter, unless the precinct official previously coded the ballot. This preserves voter anonymity.

In addition to the actual ballot images, Voter Terminals record a chronological event log. This event log includes every event that took place on the terminal: from clearing and testing for the current election, opening the polls, and votes cast to closing the polls, producing results, and finally collecting the audit data. Each event log consists of the event code, the time the event took place, and the serial number of the PEB used to activate the terminal for the event.

Protection Against Fraud

The use of PEBs to load the voter's ballot onto a voter terminal is the key to voter fraud protection. Through the PEB, precinct officials control what ballot loads onto the voter terminal. In both ballot loading systems, loading more than one ballot on a terminal is not possible, so voters never have access to more than one ballot.

When a voter inserts a voter PEB into a voter terminal, the terminal will only accept (i.e., read) that same serial numbered voter PEB, until the vote is cast. When the voter presses the VOTE button to cast the ballot, the voter PEB erases the ballot information and remains useless until reloaded with another ballot by the precinct official. In the Poll Worker Activated System, only election officials handle the precinct PEBs.

Throughout Election Day, the voter terminals at the polling location retain all ballot data (votes). The votes held within these terminals cannot be altered and can be accessed only with a supervisor PEB after the legal poll closing time. Likewise, the voter terminals can only be opened and closed by a supervisor PEB, which is in the control of the precinct officials. The voter terminals can be voted only after a ballot has been loaded onto them. Precinct officials are the only people who dispense PEBs and ballots in both ballot loading systems (one PEB/ballot to a voter), maintaining complete control.

For a more detailed description of the safeguards against vote fraud, please refer to the *Protection Against Malicious Vote Fraud* section later in this chapter.

Protection Against Over-voting

When an iVotronic System ballot is programmed, each contest is coded with the number of allowable candidate selections within that contest (e.g., vote for one race). During the voting process, the voter terminal continually reviews this code and will not allow more than the appropriate number of votes to be cast in any contest. In vote-for-one contests, the terminal automatically cancels the first vote and selects the second candidate choice for the voter. In contests where more than one candidate can be elected, the voter can vote for the allowed number candidates. If the voter tries to vote for more than the acceptable number of candidates, the terminal notifies the voter that the allowed number of candidates has already been selected and that a currently selected choice must be canceled before making a new choice. The voter terminal will continue to enforce the over-voting rules in this manner, whenever the voter's choice results in an over-vote condition.

Protection Against Power Drain

Six D-sized NiMh rechargeable batteries power the iVotronic terminal display and touch screen. Even though the batteries can be constantly recharged by plugging the terminal into a wall outlet, batteries are consumable iVotronic components and jurisdictions should conserve battery life when not using the terminals. Therefore, during normal polling place operations, the terminals power down automatically after a ballot is cast. During administrative functions, the terminals power down automatically when the PEB is removed.

ES&S programs the voter terminals to remain powered up for ten minutes with no screen activity. After ten minutes, the terminal powers down the screen and sounds an alarm to draw attention to the fact that it has been abandoned in the middle of a function. The user can bring the terminal back to normal operation by pressing anywhere on the screen. This action does not disrupt the ballot because the screen is idle at the time the screen is pressed, and no race is affected. The terminal will stop sounding the alarm and will return power to the screen after it is touched.

Protecting the Ballot Format

Supervisor PEBs and terminals retain multiple copies of all ballots. In other words, ballot data is stored in two locations inside the supervisor PEB, and three inside the supervisor terminal. However, the equipment accesses the same memory location each time the precinct official selects a ballot to load.

Using only a single memory to load the ballots allows the terminal to continually verify that the accessed memory remains identical to the originally stored memory. In other words, every time a terminal is powered up and a ballot is loaded, that ballot is checked for accuracy by comparing it with an original ballot copy. If the accessed and original ballots do not match, the terminal will notify the precinct official and will not allow the ballot to load.

Redundancy

The iVotronic Voting System design includes several redundant systems to ensure vote safety. A description of these systems follows:

Storage of Votes in Multiple Chips:

The voter terminals store all voted ballot images in three separate memory chips. Each of those chips contains a complete record of all ballots that were cast on that voter terminal. Whenever a voter terminal powers up (each time a voter begins using it), the images in those three chips are compared to each other. If they are not identical, the voter terminal issues an error message on the display and then powers down to prevent further use. This prevents large amounts of corrupt data from being stored or transferred in the system.

PEBs:

The iVotronic PEBs use lithium batteries, not AC electricity, to operate. Therefore, voting can continue normally when an AC power outage occurs at the polling place.

Terminals:

AC power is used to charge the batteries in the iVotronic and the electricity from the batteries is used to run the terminal, therefore, voting can continue normally when an AC power outage occurs at the polling place. D-sized NiMh batteries power the terminal display and touch screen only. All three memory chips in the iVotronic terminal and the chip inside the PEB are Flash-EEPROMs. These EEPROMs do not require any battery-back-up to retain their data.

Protection Against Malicious Vote Fraud

Voter terminals accumulate and store all vote totals. The supervisor PEB transports these totals to a terminal for reporting. Therefore, the voter terminal and the supervisor PEB comprise the two pieces of equipment where one might look for malicious tampering before, during, and after the election. Several interwoven safeguards deal with this area of concern. The following sections discuss these safeguards in more detail:

Prior to the Election:

- Clear and Test.
- Focused Security.
- Detect Preexisting Vote Totals.
- The Public Count.
- Voting Terminals must be Zeroed to Open.
- Opening Date and Time Recorded.

During the Election:

- Limited Master PEB Exposure.
- Terminals Check the Ballot.
- Enforce Voter PEB Qualification (Voter activated system only).
- Password Protection.
- Override Password Needed to Close Polls Early.

After the Election:

- Accountability.
- Closing Date and Time Recorded.
- Must Close Voter Terminal to Read the Votes.

Prior to the Election

Note: A thorough knowledge of the polling process aids in understanding these safeguards.

Clear and Test

Voter terminals will not open for voting by using a supervisor PEB until they have passed the "Clear and Test" function on the password-protected Service Menu. This test ensures that the Public Count resets to zero before any new election activity. In other words, no fraudulent votes can be stored on voter terminals before opening them on Election Day.

Focused Security

Voter terminals will not allow voting until properly opened by the master PEB. ES&S programs a specific number of supervisor PEBs with ballots. Election headquarters distributes these PEBs to precinct officials separately from the voter terminals. These procedures place election security in the hands of the precinct officials, instead of the security measures at the equipment storage facility.

Detect Preexisting Vote Totals

A voter terminal will not open normally for a master PEB that already contains votes. Supervisor PEBs normally store votes at the end of the election, not when the voter terminals are being opened for voting. If a master PEB has votes recorded on it, that means that the master PEB has already closed at least one voter terminal and holds a copy of that terminal's vote totals. If this master PEB continues to be used in the current election, these vote totals will be reported on the polling location results. Since this situation could conceivably be the result of malicious activities, the voter terminal always checks the master PEB for pre-existing vote totals.

If the master PEB already contains votes, the voter terminal issues a message on its screen alerting the precinct official. The voter terminal then requires entry of a precinct-specific override password before the voter terminal will open for voting. This requirement assures that the situation will be called to the precinct official's attention. If the precinct official is not aware of any voter terminals being closed with a master PEB that already contains votes, the master PEB is malfunctioning and should not be used in the current election.

The Public Count

Voter terminals display their Public Count on the screen when powered up by any PEB. Precinct officials should make sure that the Public Count is set to zero when the voter terminals are opened.

Voter Terminals Must be Zeroed to Open

If a supervisor PEB is inserted into a voter terminal to open it for voting and the Public Count is set at zero, the precinct official should receive the following message: "Open terminal now for above named polling location?" If any votes already exist on the voter terminal, the Public Count displayed on the screen will not be zero. The precinct official will get one of the two following messages instead of the normal opening message: "Do you want to close this terminal?" or "Do you want to recollect the votes?"

If the precinct official gets the "Do you want to recollect the votes?" message, it means that this voter terminal has not been "Cleared and Tested" since the last election. If the precinct official receives the "Do you want to close this terminal?" message, the voter terminal is open for voting and may or may not have votes on it, depending on the Public Count. This open terminal may be the result of attempted vote fraud. However, the result is more likely an issue of election officials testing the voter terminals in advance of the election. These officials may have neglected to close a voter terminal after testing. In both cases, the precinct official will need to have trained service personnel "Clear and Test" the terminal before using it in the current election. Service personnel are required because of the password protection feature of the voter terminal Service Menu and the "Clear and Test" option itself.

Opening Date and Time Recorded

Access to the "Set Date and Time" feature is password-protected. The current date and time setting displays every time the voter terminal powers-up by any PEB. The voter terminal always records the exact date and time that it was opened for voting. The polling location report always includes the opening date and time for each voter terminal.

During the Election

Limited Master PEB Exposure

Typically, each polling location has only one master PEB on site. Precinct officials always maintain control and possession of the master PEB, because it runs the election. The master PEB opens the voter terminals for voting at the beginning of the election, cancels or casts any unfinished votes if necessary, closes the polls, collects the votes, and issues the polling location report. At all other times, the master PEB remains idle.

Terminals Check the Ballot

Voter terminals ensure that the incoming ballot has the same unique ballot qualification code that was programmed into the supervisor PEB and used to open the terminals for voting. If the ballot is not coded for this precinct and this election, the voter terminal will not accept it for voting. Instead, the voter terminal will issue an audible alarm and display a message explaining that this PEB has not been qualified properly, and cannot be used in this election until it has been reprogrammed.

Enforce Voter PEB Qualification (Voter Activated System Only)

Before the supervisor terminal loads a ballot into a voter PEB, it checks for the unique ballot identification code from the last loaded ballot. If no previous ballot identification code exists on the PEB, the supervisor terminal loads the ballot normally. If the ballot identification data on the voter PEB matches the ballot identification code that is about to be loaded onto the voter PEB, the supervisor terminal loads the ballot normally. However, if the ballot identification code in the voter PEB does not match the unique ballot identification code for the current precinct and election, the supervisor terminal issues an audible alarm. It also displays a message explaining that the voter PEB has not been properly qualified since the last election, and cannot be used in this election until it has been qualified.

Password Protection

Password protection restricts access to the Service Menu and the Elections Central Applications Menu. These menu passwords differ from the precinct-specific override passwords that precinct officials issue if a deviation in the election process arises. The ballots for each election contain different precinct-specific override passwords (i.e., the passwords change for each election). Typically, election officials do not divulge the menu passwords to precinct officials. If precincts require the Service Menu or Elections Central Applications Menu passwords, extenuating circumstances exist and trained service personnel should be present at that polling location to oversee the situation.

Override Passwords Needed

A prompt for an override password can be expected in the following circumstances:

- Closing the polls early.
- Opening a voter terminal with a PEB that already contains votes.
- Issuing a polling location report without closing all opened voter terminals.
- Clearing and Testing a terminal that has not been closed.

As an added precaution against pre-election vote fraud, voter terminals cannot be closed and have their votes collected before the official election closing date/time. A precinct-specific override password that accompanies the ballot is required for this situation. To close the polls in pre-election testing, election officials need to access the override password for each precinct ballot that is to be tested.

Override passwords are required because the iVotronic recognizes these four situations as deviations from the prescribed order of election events. These deviations sound an internal alarm. However, the election process must continue. Therefore, override passwords are used to bypass internal alarms and allow official deviations. The passwords ensure that precinct officials are notified that an alarm condition has occurred while allowing execution of the election process. Election headquarters has discretion when providing precinct officials with override passwords.

After the Election

Accountability

The master PEB used to open all voter terminals at the beginning of the election also produces a zero tape. This zero tape shows which serial number terminals were opened, exactly what date and time they were opened, and the number of votes on each voter terminal when it was opened (which by definition should be zero).

That same master PEB closes all voter terminals and collects all votes. Because the master PEB recorded the serial numbers of all opened voter terminals, it demands that all of these opened voter terminals also be closed. This feature helps precinct officials make sure no terminals were missed. If a reason for not closing a terminal develops, the precinct official can enter an override password and proceed normally. However, the polling location report still includes the serial numbers of any unclosed voter terminals and lists them as "Not Closed."

Closing Date and Time Recorded

When closed, voter terminals include their closing date and time on the master PEB. The master PEB then reports the closing date and time for each voter terminal, directly beneath its corresponding opening date and time on the polling location report. This allows election officials to audit when each voter terminal was opened and closed on Election Day, and this information can be compared to the zero tape that was produced during the opening process.

Must Close Voter Terminal to Read the Votes

The master PEB must first close a voter terminal before it can collect the terminal vote totals. Once closed, the voter terminal cannot be voted on again until it is "Cleared and Tested" and opened for voting. When a master PEB closes a voter terminal, the voter terminal reads the master PEB first to see if this master PEB has already closed and collected vote totals for this serial number voter terminal. If it has, the voter terminal will not copy its vote totals to the master PEB.

Chapter 8: Contingency Plans

The iVotronic Voting System design provides full, high quality service for an indefinite lifetime. However, elections are important, time-critical events. Therefore, contingency plans for the failure of the iVotronic hardware must be in place. The iVotronic Voting System design never loses election data, even if its power source fails during the election process.

Supervisor Terminal Failure

If the supervisor terminal malfunctions, check the battery orientation. Make sure the battery pack is inserted properly. If the battery pack is inserted correctly, replace it with a new battery pack and retry the operation.

If the batteries are not the problem, switch to the backup supervisor terminal. Open it with the same supervisor PEB that opened the voter terminals and continue normally. No perceivable difference in precinct operation should occur.

Master PEB Failure

Voter terminals store all opening and closing times within themselves. If a master PEB becomes inoperable or lost, use a backup supervisor PEB and make that the new master PEB. The only operational difference occurs during poll closing. If a master PEB fails, the new master PEB will not recognize any voter terminal's serial numbers that were opened, but not closed before results printing.

Voting Terminal Failure

If a voter terminal malfunctions, first check the battery pack. Make sure the pack is inserted correctly. If the battery pack is properly inserted, replace it with a new battery pack and try the operation again.

A catastrophic failure is any event, other than a battery failure, that causes the voter terminal to cease functioning during an election. Such a failure can be caused when a terminal recognizes non-matching data in one of the three memory chips during the voter terminal start-up and internal checks sequence.

If batteries are not the problem, retire this failed voter terminal from service for this election. Close the voter terminal normally at the end of the election, if possible. If the voter terminal cannot be closed normally, contact ES&S as soon as possible for retrieval of the votes and/or audit trail data from the memory chips inside the voter terminal.

In the unlikely event of catastrophic voter terminal failure, ES&S has developed a method of retrieving votes from the FLASH-EEPROM removable memory chips.

If a voter terminal fails during the act of voting, the ballot in progress on the voter terminal will not be saved. The Public Count and the Protective Counter will not increment. The voter that was using the voter terminal at the time it failed should receive another ballot for voting.

Voter PEB Failure

If a voter PEB malfunctions, examine the small red communications window for dust. If dusty, blow it off with a quick puff of dry air and try the operation again. If that does not solve the problem, set that voter PEB aside for this election and use the remaining voter PEBs. Return the malfunctioning voter PEB to ES&S for servicing after the election.

Two internal lithium batteries with a projected life of eight years power all PEBs. Because all PEBs are tamper resistant, there are no user-serviceable components.

Printer Failure

Check the Power Switch

If the printer fails to print, first verify that the power switch has been activated. If the green light next to the "POWER" label is illuminated, the switch is on and there is power to the printer.

Check the Cables

Check the communications cable between the terminal and the Communications Pack. Verify that it is plugged firmly into the back of the terminal and the selector switch. To ensure proper connection, disconnect and reconnect the cable ends.

Check the Batteries

If the power switch is on and there is no power, turn the switch OFF and check the batteries in the Communications Pack to verify that they are inserted in the proper direction. If all batteries face the proper direction, replace them with a new set of six D-cell batteries. After new batteries have been installed, move the power switch to the ON position again and retry the operation.

Check the Paper Tape

Verify that the paper tape is not jammed. Press the Feed button on the top of the printer. The paper should advance. If the paper does not advance, turn the printer over to its back. Lift the printer paper cover and feed the paper through the slot in the back. Once the paper contacts the paper feed, the printer will automatically feed the paper through the printer. Close the printer paper cover and turn the printer over to its normal position.

Check the Printer Ribbon

On a dot-matrix printer remove the printer cover after turning off the printer. Verify that the ribbon stretches between the printing head and the platen. If the ribbon is not placed properly, remove and reinstall it. Then, press down on the ribbon cassette and wind up the ribbon slack by turning the knob in the direction of the arrow.

Swap Printers

If none of the previous steps fix the printer problem, swap the Communications Pack with the spare for this polling location, or if using a dot-matrix printer replace it with a spare. Even if both printers fail, the votes can still be read and reported from the master PEB at election headquarters.

Failed Modem

When the modem works properly, it should produce sound from its internal speaker. There will be the sound of a dial tone from the phone line, the sound of a tone dialing, ringing of the phone on the other end, and several varying tones over static as the two modems determine what speed and protocol they will use to communicate.

Check Phone Line

If the modem fails, check the telephone line that connects to the modem. Verify that one end is properly connected to the RJ11 jack in the Communications Pack and the other end connects to the RJ11 jack that should be providing a dial tone from the phone company.

Check Cable

Check the communications cable between the terminal and the selector switch. Verify that it is plugged firmly into the RS232 port at the back of the terminal and the selector switch. Check the communications cable between the output selector switch and the modem in the same manner.

Swap Modems

If the troubleshooting procedures above do not alleviate the problem, swap this Communications Pack with a spare Communications Pack.

Rely on PEB

Even if the phone line or both modems were to fail, the votes can still be read from the master PEB at election headquarters. Simply deliver the master PEB that was used to close all of the voter terminals to the election headquarters for counting.

Error Messages

The iVotronic Voting System issues very few error messages. Most messages on the screen are simply helpful reminders, instructions, or menus offering choices to the user. However, if severe problems develop, the following signals are likely to appear.

Battery Failure

If the terminal's power-up self-test detects low battery power (5.5 volts or less), the terminal will beep once and display a message that battery voltage is low. The voter can proceed with the current ballot, but the precinct official should recharge the batteries before the next function.

Error: 256: 16384

When battery power falls below 5.2 volts, the terminal will issue the following message: "Batteries too low to continue." This message occurs at power up and indicates the batteries are too weak to support the screen display. When this message appears, remove the PEB. Open the battery cap on the terminal, replace the battery pack with a new one, and insert the PEB again. If a voter terminal fails while in use by a voter, the vote is not recorded and the voter should be provided with another ballot to vote.

Internal Malfunction, Terminal is Shutting Down

When the vote data in one of the three-vote storage memory chips no longer match the image stored in the other two memory chips, the above message is displayed. To prevent vote image corruption, the terminal shuts down. Contact ES&S as quickly as possible for retrieval of the votes from the terminal memory. *DO NOT* attempt further voting on this terminal.

Troubleshooting

Terminal Screen is Difficult to Read (Too Dark or Too Light)

Call ES&S for technical service if the terminal screen is too dark or too light. Use a spare terminal until the malfunctioning terminal can be repaired.

Terminal Emits a Chirping Sound

There are two reasons that the voter terminal would emit a chirping noise: if the voter leaves the terminal without pressing the red VOTE button to complete their voting process, and if the batteries are running low. Follow the guidelines below for your applicable circumstance.

Voter Prematurely Leaves Terminal

1. If the voter departs without pressing the red VOTE button, the terminal will continue stay exactly as the voter left it for approximately 10 minutes. Then, the terminal begins chirping and turns the back light out to save power. Press the screen to continue.

2. If the voter does not return to the terminal to continue voting, the poll official may either cast the ballot for the voter as he/she left it, cancel the ballot, or cast a blank ballot, depending on the jurisdiction's laws.
3. To cast the ballot, simply press the screen to bring up the ballot. Then, press the red **VOTE** button to cast the ballot. The terminal records the ballot exactly as the voter left it and automatically powers down. The terminal is now available for the next voter.
4. To cancel a ballot, reinsert a red supervisor PEB into the terminal. The terminal displays the message "Last ballot was not cast" and gives you two options: "Cast Blank Ballot" or "Cancel Ballot."

To cast the ballot as blank, press the box next to **Cast Blank Ballot**. No votes will be recorded, but the terminal's Public Counter will increase by one. Casting a blank ballot is the only way to record a protest vote.

To cancel the ballot, press the box next to **CANCEL Ballot**. The terminal then displays the message: "Cancel Ballot?" Press the box next to **Yes**. The ballot will be canceled and the terminal Public Counter will not increment.

Failure to Print Zero Tape

When opening the polls, if a poll worker accidentally presses **No** when prompted to print zero tapes:

1. Simultaneously insert the PEB while pressing against the screen. The message "Do you want to close this terminal?" will appear.
2. Press **No**. The next message, "Print this terminal's zero tape now?" will allow the zero report to be printed.

Appendix A: ADA Functions

The iVotronic complies with the Americans with Disabilities Act by providing special keys and audio cues for the visually impaired.

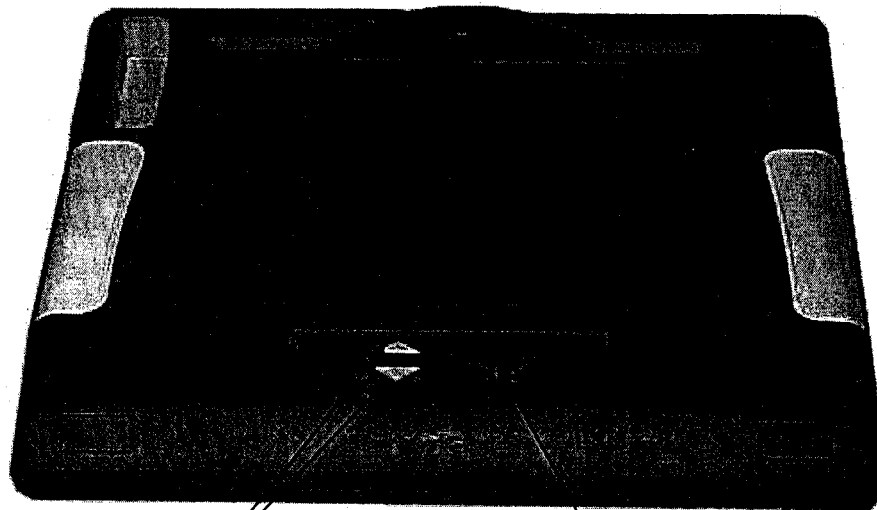

ADA Scroll Buttons

ADA Selection Button

Before voting begins, iVotronic terminals that are ADA equipped will prompt the election official or voter to select either **Visual** or **Voice** operation. Highlight the desired mode with the arrow shaped ADA scroll buttons and press the diamond shaped ADA selection button to confirm the choice.

Note: ADA equipped iVotronic terminals must have headphones attached for **Voice** mode to work properly.

When **Visual** is selected the iVotronic will work normally, allowing the voter to select candidates and options by pressing the touch screen and confirming completed ballots and selections with the red VOTE button.

In **Voice** mode, selections are made using the ADA scroll buttons and the diamond shaped ADA selection button. The touch screen is disabled in **Voice** mode to prevent accidental selections. As each candidate, office or selection is scrolled over; stored audio cues provide a vocal description of the selected option.

To vote in **Voice** mode:

1. Put on the attached headphones and select **Voice** mode using the ADA scroll buttons. Confirm the selection by pressing the diamond shaped ADA selection button.
2. The iVotronic will vocally prompt the user to press the diamond shaped button for voting instructions.
3. After instructions are given, the user will have the opportunity to listen to the instructions again by pressing the up scroll button followed by the diamond selection button or to begin making ballot selections by pressing the down scroll button followed by the diamond selection button.
4. When a contest is scrolled over, the terminal will prompt the voter with the office title, the number of candidates that can be selected for the office and the number of candidates running for the office. Press the diamond shaped selection button to vote the contest or the down scroll arrow to move to select the next contest.
5. When a contest is selected, the terminal will provide a vocal cue informing the voter which candidate is highlighted and the ballot position that the candidate is in. Press the down scroll arrow to advance to the next candidate or press the diamond selection button to select the current candidate. Press the diamond shaped button again to cancel the candidate selection or press one of the scroll arrows to continue moving through the ballot.
6. The voter can enter a write-in candidate by scrolling through letters from an audible alphabet and selecting the appropriate letters using the diamond selection button.
7. When the end of the ballot is reached, the voter will be prompted to press the diamond selection button or the VOTE button to cast the ballot. Press the up scroll arrow to return to voting or the diamond shaped selection button to cast the ballot. When the selection button is pressed, a message will be heard asking if the ballot is to be cast. Press the diamond selection button again to confirm and cast the ballot and finish voting.

Note: An audible cue will be played thanking the user for voting after the ballot has been cast.

Recording Voice Files

ES&S recommends that you have the voice files for the iVotronic ADA function created by a professional sound studio or by ES&S. If you decide to record the voice files on your own, you will need the following:

- Sound recording software
- Compact flash card reader/writer
- Microphone

To record voice files for the iVotronic ADA functions you will need to name each voice file so that it corresponds with the written ballot as indicated in the Election Data Manager Votronic Audio Report. To view this report:

1. Open Election Data Manager, then open the election for which you are making the voice files (Select **Open Election** on the File menu).
2. Select **Votronic Reports** from the Reports menu.
3. Select **Votronic Audio Report**. This report lists the file name that must be used for each voice file created (i.e. the voice file for the candidate Tom Cottar must be named 1C00001.WAV).

Votronic Audio Report

LANGUAGE	DESCRIPTION	AUDIO FILE
English	Republican	1C99000.WAV
	Democratic	1C99001.WAV
	Libertarian	1C99002.WAV
	Tom Cottar	1C00001.WAV
	Nick Lampson	1C00002.WAV
	Candidate C	1C00006.WAV
	George W. Bush	1C00003.WAV
	Garry Mauro	1C00004.WAV
	Candidate C	1C00005.WAV
	Rick Perry	1C00007.WAV
	John Sharp	1C00008.WAV
	Candidate C	1C00009.WAV

Note: Record the voice files at 11.025kHz, 8 bits for the best results.

Transferring Voice Files to the iVotronic

Once the voice files are recorded and named correctly they must be moved from their location on the recording computer's hard drive to a compact flash card which the iVotronic reads.

1. Install the compact flash card reader/writer to the computer according to the manufacturer's instructions. The flash card reader/writer will appear as a standard disk drive in Windows Explorer.
2. Make sure that there is a blank card in the reader/writer.
3. Use Windows Explorer to copy and paste (or drag and drop) the voice files from the location where they were originally saved, to the root directory of the compact flash card reader/writer (Do not place the files into a folder or subdirectory on the compact flash card reader/writer drive).

The compact flash card must be plugged into the iVotronic to enable the audio ballot.

Appendix B: Three Steps to Voting (Poll Worker Activated System)

1

Use the stylus to press inside the box to the right of your choice(s). When selected, your choice highlights and an "X" appears in the box. **

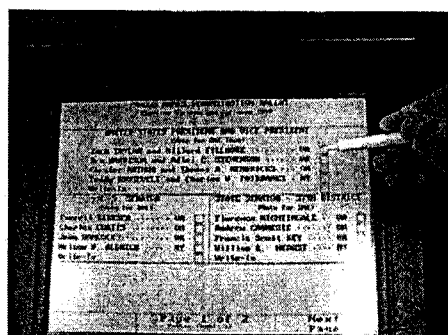

2

To continue, press the "Next Page" box. To review, press the "Previous Page" box. You must "View" all pages of the ballot before casting your vote.

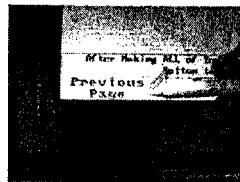

3

When finished making all your choices, press the illuminated red VOTE button to record your vote.

Press the Illuminated Vote Button

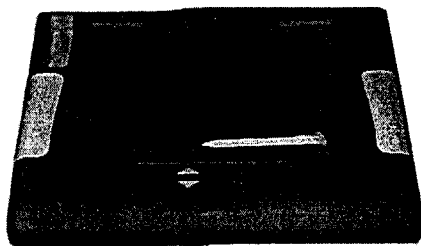

TO CHANGE A CHOICE: Simply press inside the box of your new choice. In multi-seat (vote for more than one) offices, it may be necessary to cancel a choice(s) before making a new choice.

TO CANCEL A CHOICE: Simply press inside the same box a second time and the highlight and the X will disappear.

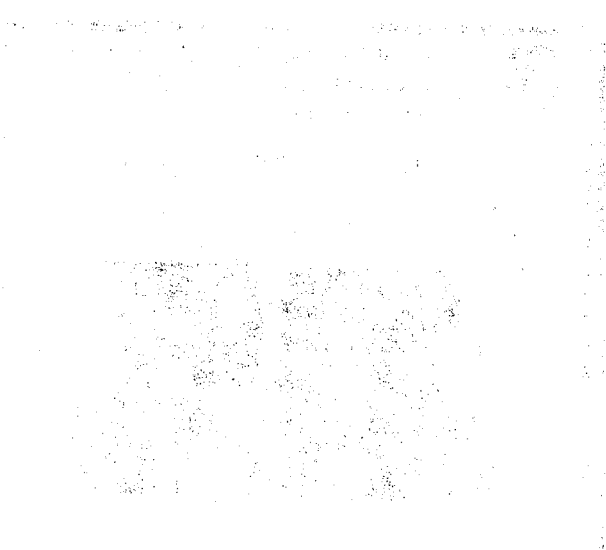
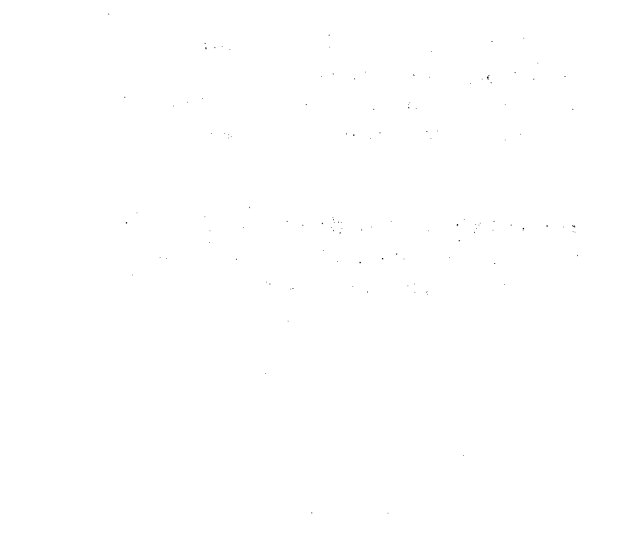
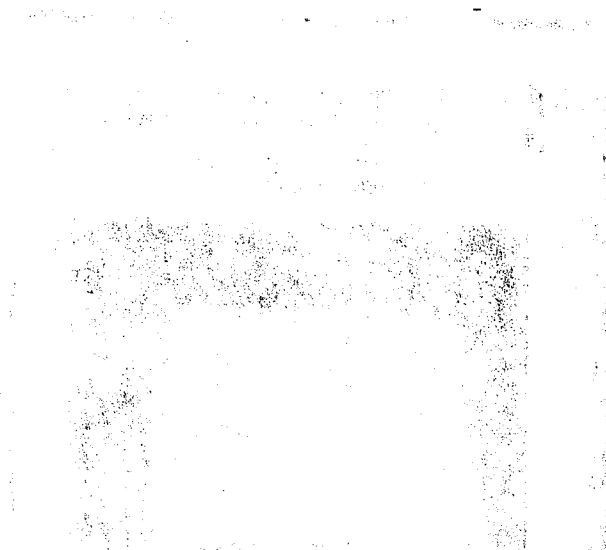

Appendix C: Four Steps to Voting (Voter Activated System)

1

Insert the blue voter PEB into the voter terminal. The ballot will appear on the screen.

Insert PEB into Slot

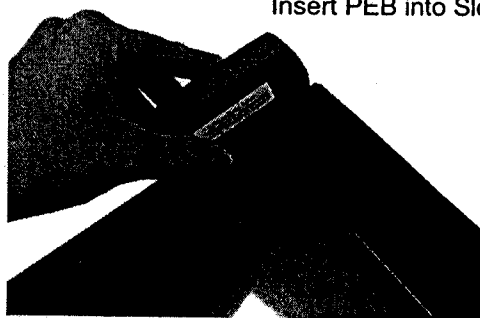

2

Use the stylus to press inside the box to the right of your choice(s). When selected, your choice highlights and an "X" appears in the box. **

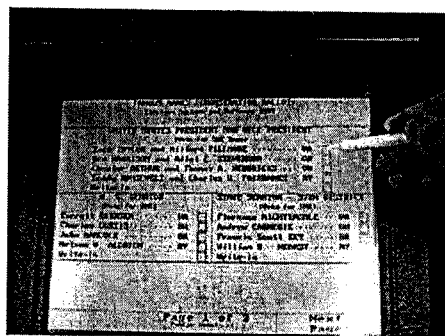

3

To continue, press the "Next Page" box. To review, press the "Previous Page" box. You must "View" all pages of the ballot before casting your vote.

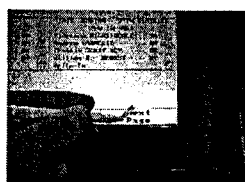
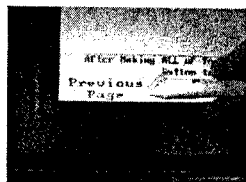

4

When finished making all your choices, press the illuminated red VOTE button to record your vote.

Press the Illuminated Vote Button

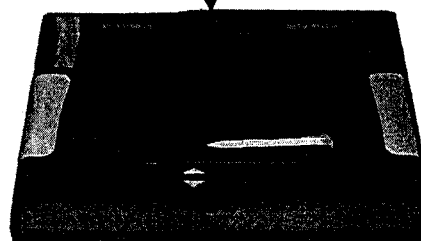

TO CHANGE A CHOICE: Simply press inside the box of your new choice. In multi-seat (vote for more than one) offices, it may be necessary to cancel a choice(s) before making new choice(s).

TO CANCEL A CHOICE: Simply press inside the same box a second time and the choice will cancel and the X will disappear.



Appendix D: Glossary

BALLOT LOADING SYSTEM: A specific method of loading ballots onto voter terminals. The two ballot loading systems require different equipment configurations and functions. In addition, the ballot loading system in place at a jurisdiction influences the course of other operational procedures. ES&S defines ballot loading systems as either poll worker activated or voter activated.

CHIRPING TONE: A distinct series of rapid audible tones, generated by the iVotronic terminals indicating either a user response is required or an error has been detected.

CLEAR and TEST: A selection on the iVotronic Service Menu that permanently clears all terminal memory, thoroughly tests the internal circuitry, and clears the terminal public count. All terminals must be cleared and tested before a new election. Terminals that are not cleared and tested will not open for voting.

CODED BALLOT: A ballot marked with a code by election officials. The code allows the ballot to be located in the audit data. By law, ballots must be able to be coded.

COMMUNICATIONS PACK: A case of communication equipment that facilitates the transfer of election data from a master PEB through a iVotronic terminal and into a user-friendly format, such as a report. The equipment includes a selector switch, a serial printer, and an optional modem. The printer prints zero tapes at poll opening, and final polling location results tapes at poll closing. The modem transfers polling location results to election headquarters immediately at poll closing. The Communications Pack connects to a iVotronic terminal for election data transfer via a RS232 cable.

DATABASE: The body of jurisdiction-specific data or information used for ballot formats and election programming. ES&S Election Preparation Software Package, which is available for purchase, includes the database format. The purchase of a database allows jurisdictions to program their own elections. Otherwise, ES&S provides programming services on a cost basis per election.

ECA: Election Central Application refers to a iVotronic menu option. The ECA Menu provides the user access to pre and post election administrative functions.

EEPROM: Electronically Erasable Programmable Read Only Memory is a memory chip that can be written and rewritten. The EEPROM contains the system operating Firmware.

INIT: Initialization String is a series of commands that define and initialize modem operation. Generally, ES&S preprograms this code into the master PEB for results reporting. If a need for this code arises, consult your modem instruction manual.

MEMORY CHIPS: A location on iVotronic terminal's CPU Board that stores vote totals and other election data. Three independent flash memory chips retain identical vote totals in each terminal. These memories do not require battery backup.

MODE: A specific functional arrangement within the iVotronic System that provides particular user options, referred to as the Election and Service Modes.

PC: Personal Computer - When used in this or any other iVotronic Manual, PC refers to an IBM-compatible personal computer.

PEB: Personalized Electronic Ballot - A hand-size cartridge that includes an infrared communications window and one memory chip, which store ballot information and other election data. PEBs activate the iVotronic terminals and load ballots onto voter terminals for voting.

PROTECTIVE COUNT: A running numerical total of votes cast on a specific terminal from the time of its production. The terminal displays the protective count when the terminal is first activated, and it can never be zeroed or erased.

PUBLIC COUNT: The total votes cast on a specific terminal in the current election. The terminal displays the public count when the terminal is first activated, and it is zeroed or erased when a terminal is cleared and tested.

QUALIFICATION CODE: A computer-generated, election-specific eight digit code. However, you are only able to view the last four digits for security reasons. Because this code separates audit data trails, it must be changed for each election via the "Start Election Qualification Trail" function on the ECA Menu. The "Start Election Qualification Trail" function should be completed first before any other programming or equipment preparation. Always use a PEB or terminal with the upcoming election Qualification Code to prepare other equipment.

QUALIFICATION TRAIL: The process of transferring the election-specific Qualification Code from the supervisor terminal where it was generated to PEBs and from those PEBs to other terminals during election programming and equipment preparation.

QUALIFY PEB: A selection on the iVotronic Service Menu that permanently clears PEBs of all previous election data and issues the PEB a new election-specific Qualification Code. All PEBs must be qualified before a new election. PEBs that are not qualified will not properly activate iVotronic terminals.

RANDOMIZED AUDIT DATA: A body of data consisting of actual ballot images and codes, if applicable. Audit data is recorded randomly on voter terminals according to a rolling millisecond timer and does not report with other election results on the Results Tape. Officials may retrieve audit data one terminal at a time after an election.

RS232 CABLE: A communications cable that connects the Selector Switch in the Communications Pack to any iVotronic terminal via the RS232 Port.

RS232 PORT: The communications port located on the center back of all iVotronic terminals. This port connects with the RS232 cable in the Communications Pack for results reporting.

STYLUS: A white, hard, plastic, pen-shaped object that is attached to the front of each terminal by a string. The stylus is used to press the terminal touch screen in designated locations that indicate specific user choices, such as ballot type and candidate.

TERMINAL: An iVotronic term referring to the main unit used in the voting system. Voters use terminals to select their candidates and cast their ballots. Election officials use terminals to open and close the polls, load ballots for voters, and report results.

TOUCH SCREEN: The interface between the iVotronic software and the system user. The touch screen displays instructional, status, and error messages. Users press directly on the touch screen in designated locations to indicate preferences.

[The text in this section is extremely faint and illegible. It appears to be a series of paragraphs, possibly containing a list or detailed notes. The content is mostly lost to the quality of the scan.]





ELECTION
SYSTEMS & SOFTWARE

The following products and services are available from ES&S:

Unity Election System™

Election Data Manager™

Ballot Image Manager™

Ballot on Demand™

Hardware Programming Manager™

Data Acquisition Manager™

Election Reporting Manager™

Profile Voter Registration Systems™

Power Profile™

Mega Profile™

State Profile™

Ballot Counting Systems

Systems for use at the Precinct or Polling Place – Electronic Ballot:

Votronic® DRE Touch Screen Voting System

V-2000 Full Face DRE Touch Panel Voting System

EZ-Access Voting™ ADA Compliant Voting Kiosk

Systems for use at the Precinct or Polling Place – Paper Ballot:

Model 100 OMR System

Model 2100 Punch Card System

Systems for use at Central or Regional Locations – Paper Ballot:

Model 150 OMR System

Model 550 OMR System

Model IV-C OMR System

Election Services and Support

On-site Training and Election Day Support

Election Programming Services

Comprehensive Training Programs and Tools

Maintenance Programs

Toll Free Phone and On-line Support

Ballot Printing Services

Systems and Procedures Documentation

Complete Inventory of Election Supplies

If you would like more information on any of our products or services please contact us:

Election Systems & Software, Inc.

11208 John Galt Blvd.

Omaha, NE 68137

Phone: 402-593-0101

Toll Free Inside the U.S.: 1-800-247-8683

Fax: 402-593-8107

Visit our website at www.essvote.com

Advancing the Way the World Administers Elections

